

**Bądź na bieżąco
- Polub nas!**

*Specjalne oferty
i okazje dla fanów.*

 **fb.com/DlaBelfra**



redpunkt.
DRUKARNIA

NOTA PRAWNA – ZAKAZ KOPIOWANIA

Projekt objęty jest ochroną wynikającą z ustawy z dnia 4 lutego 1994 r. o prawie autorskim i prawach pokrewnych (Dz. U. 1994 r., nr 24, poz. 83 z późniejszymi zmianami).

Właścicielem autorskich praw majątkowych jest KRZYSZTOF JÓŹWIAK, prowadzący działalność gospodarczą pod firmą redpunkt KRZYSZTOF JÓŹWIAK z siedzibą 42-700 Lubliniec, ul. Piaskowa 31, NIP: 575-188-49-82.

Klient, który dokonał zakupu projektu uzyskuje zgodę jedynie na jego drukowanie na własny użytek w niezmienionej formie.

Właściciel autorskich praw majątkowych zastrzega, że dalsze rozpowszechnianie projektu jest zabronione, niezależnie od celu w jakim rozpowszechnienie miałyby nastąpić.

Zabrania się kopiowania i rozpowszechniania całości projektu pod groźbą sankcji karnych.



Narysuj po śladzie i pokoloruj obrazek.

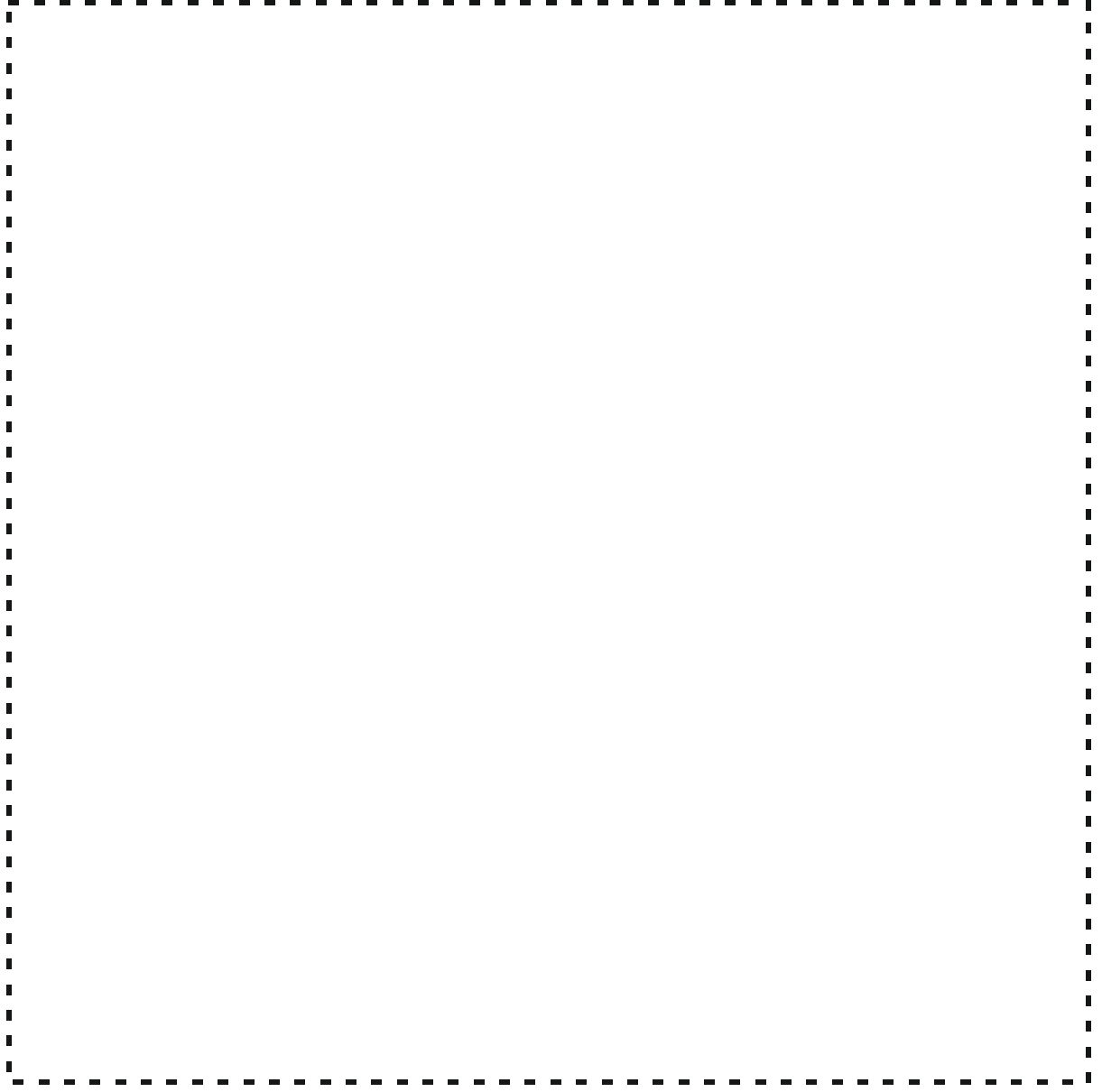

Narysuj po śladzie i pokoloruj obrazek.



Narysuj po śladzie i pokoloruj obrazek.

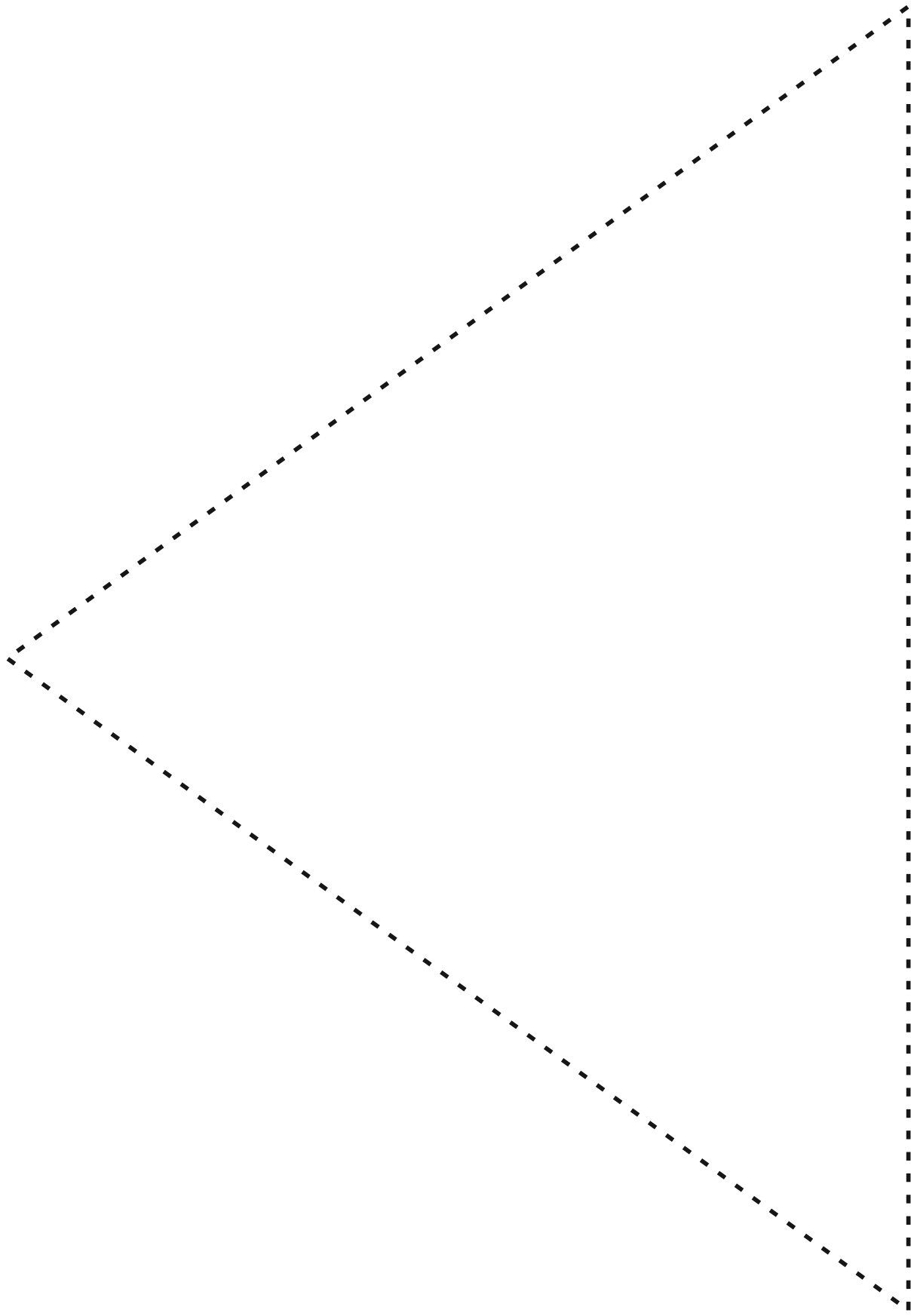

Narysuj po śladzie i pokoloruj obrazek.

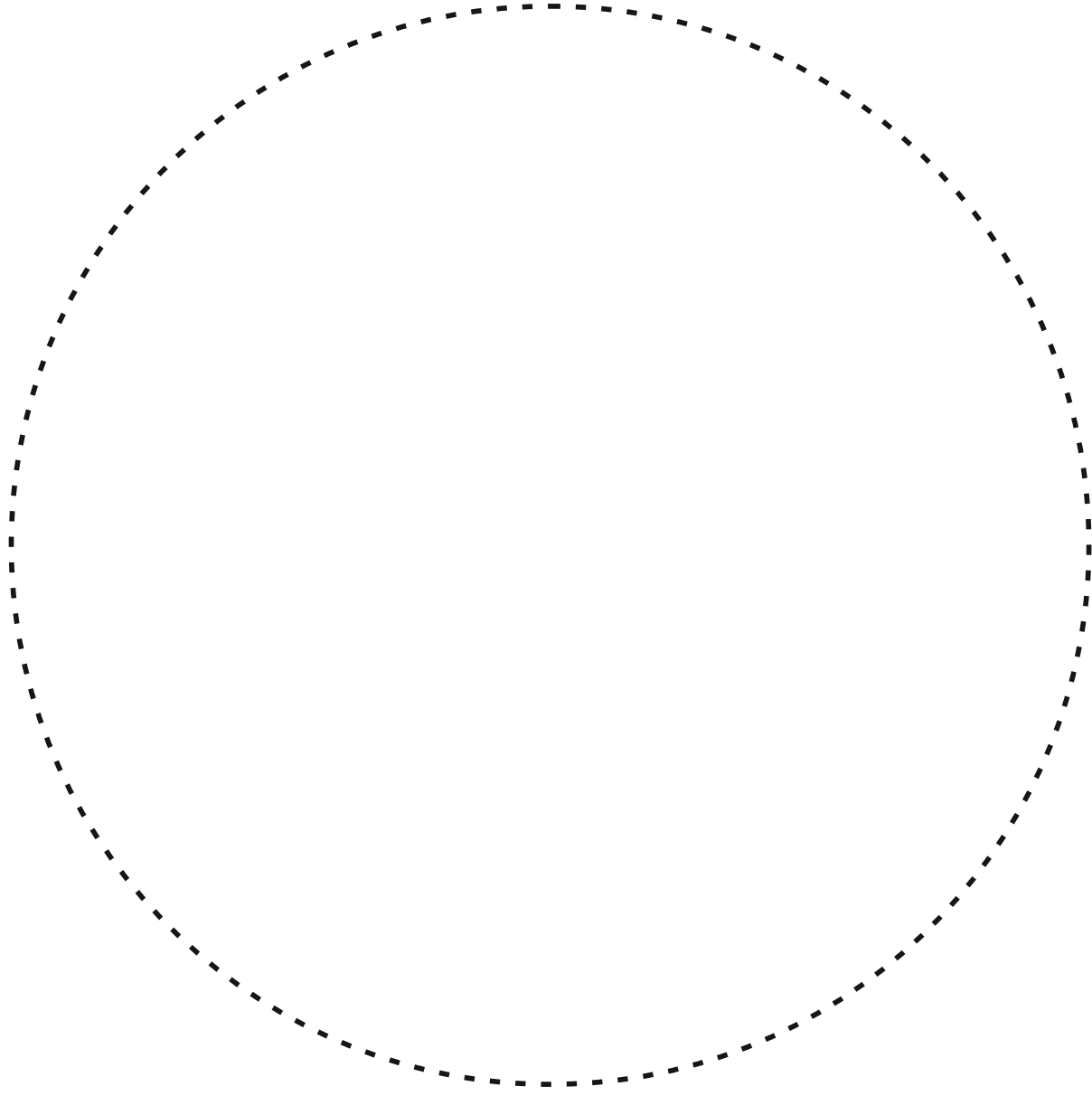

Stwórz swoją tęczę. Narysuj po śladzie i pokoloruj obrazek.

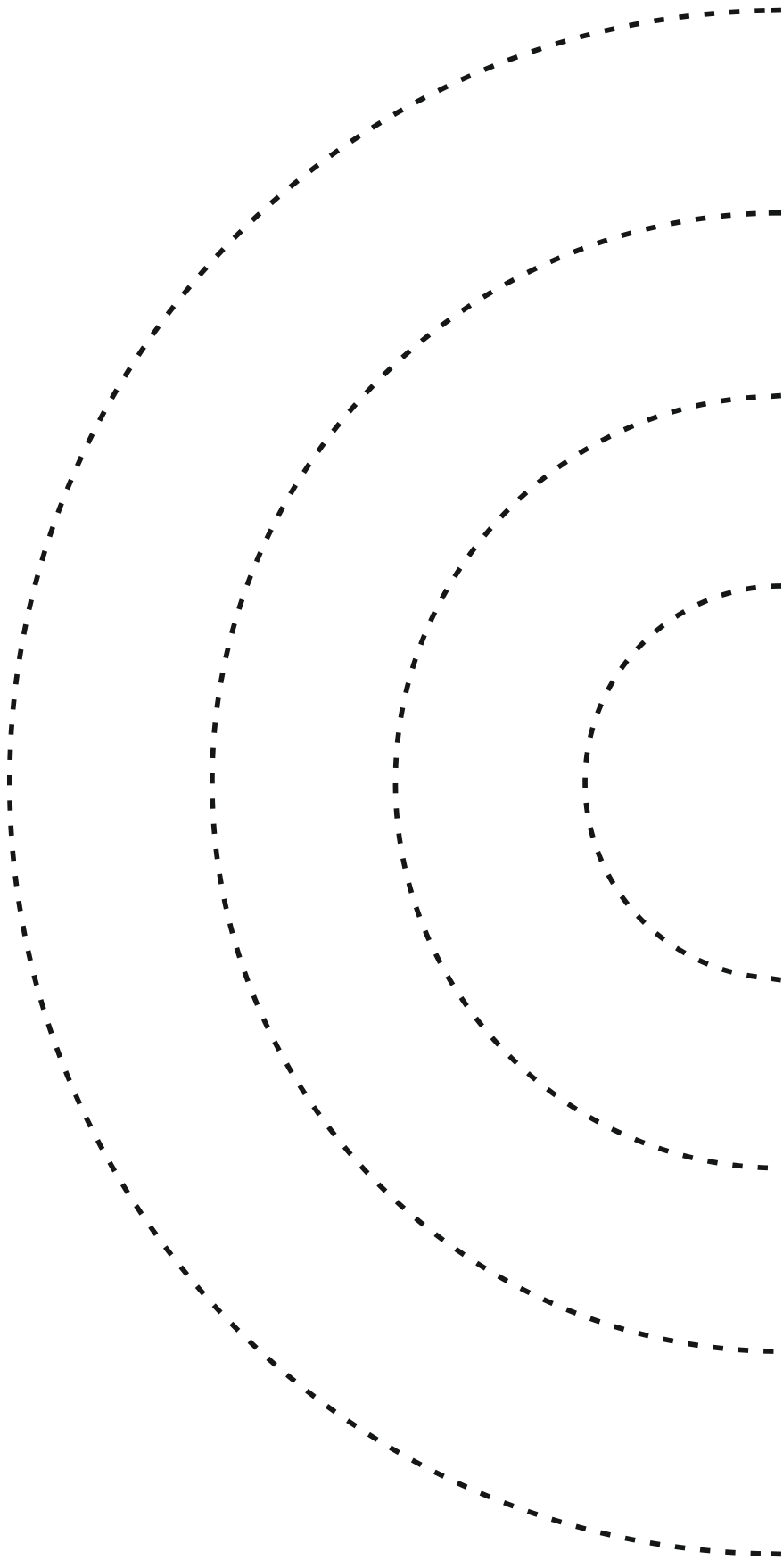

Narysuj spiralę po śladzie.

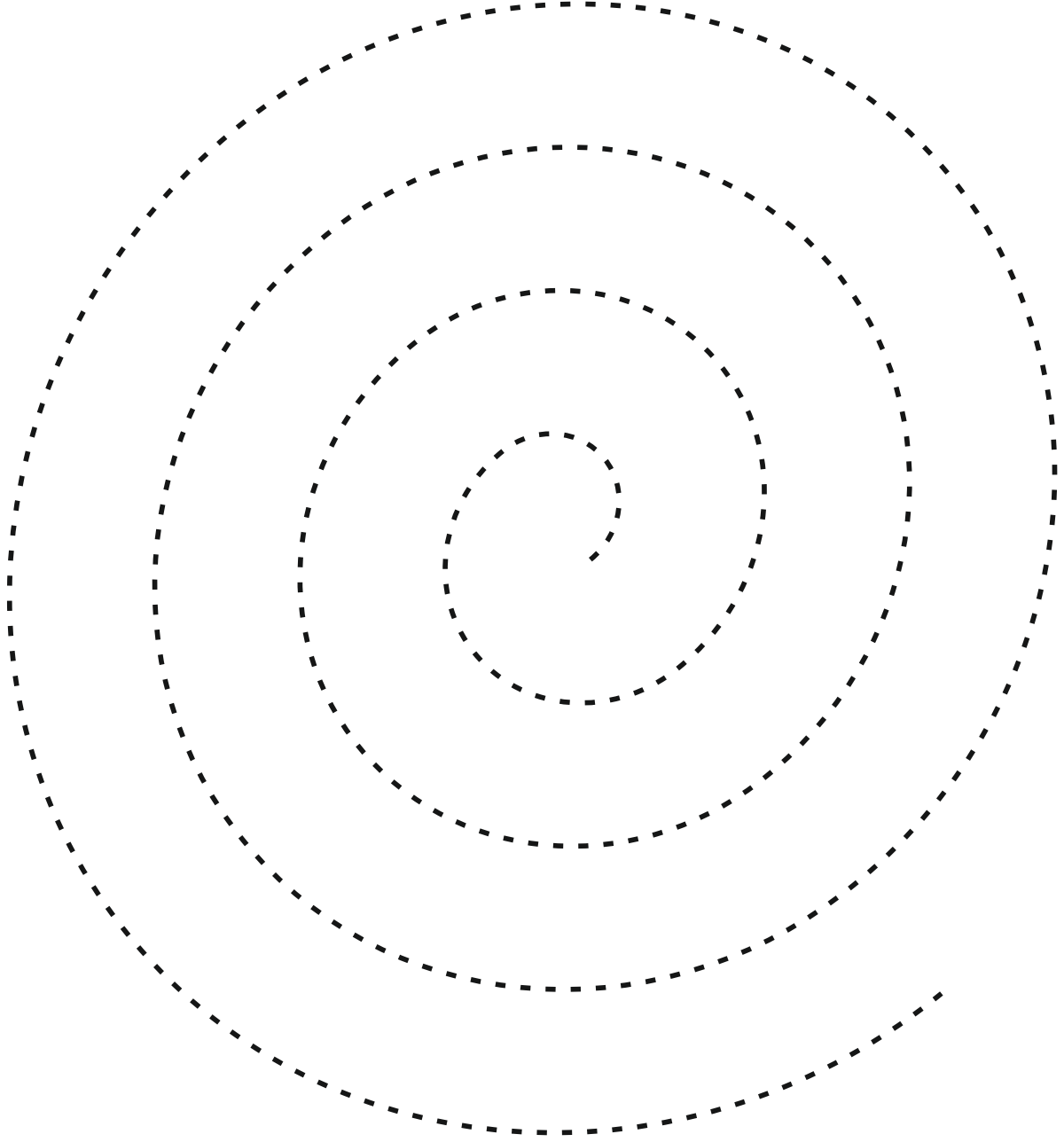

Narysuj po śladzie i pokoloruj obrazek.

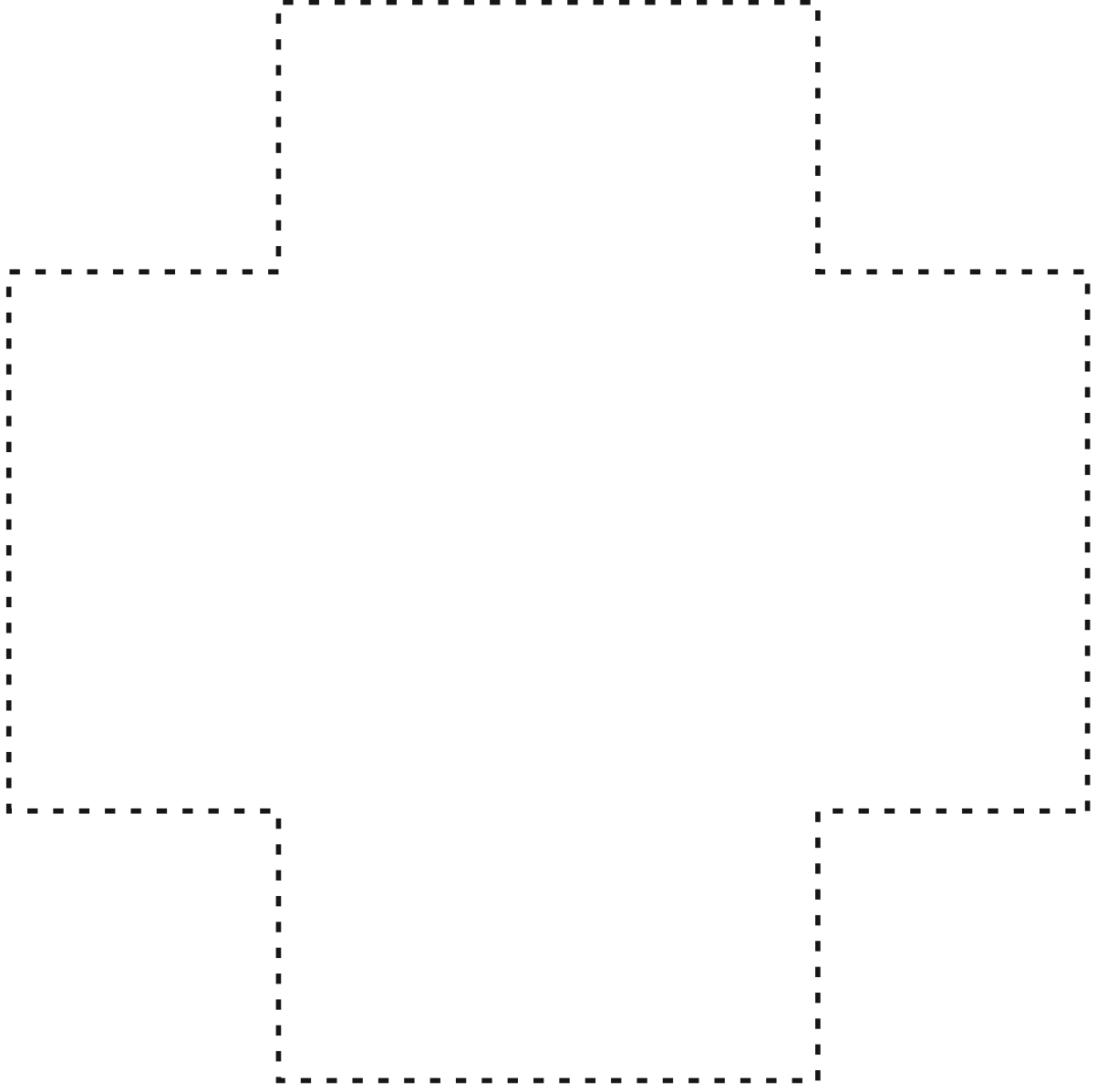

Narysuj po śladzie i pokoloruj obrazek.

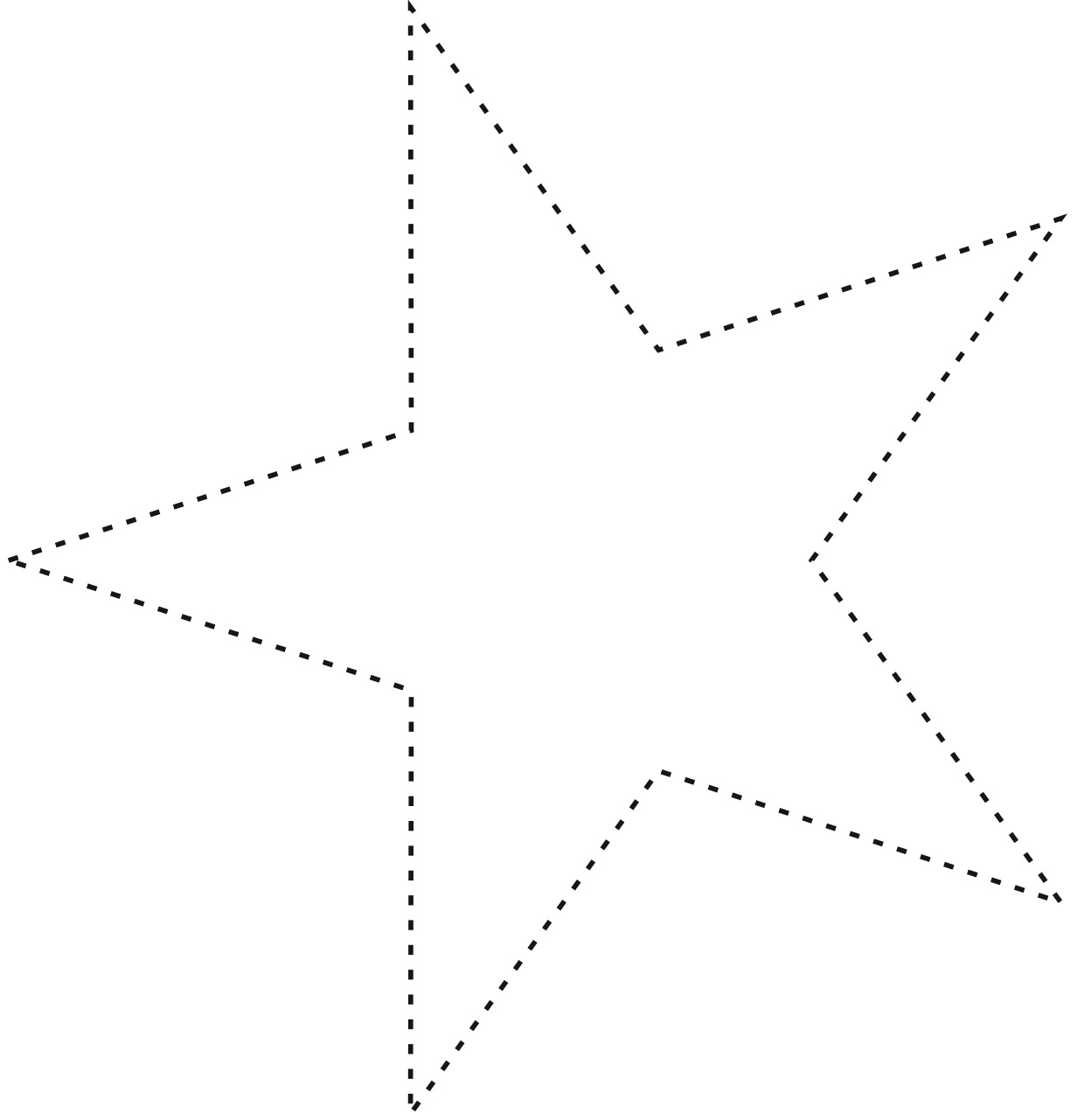

Narysuj buzię po śladzie i dorysuj pozostałe elementy twarzy.

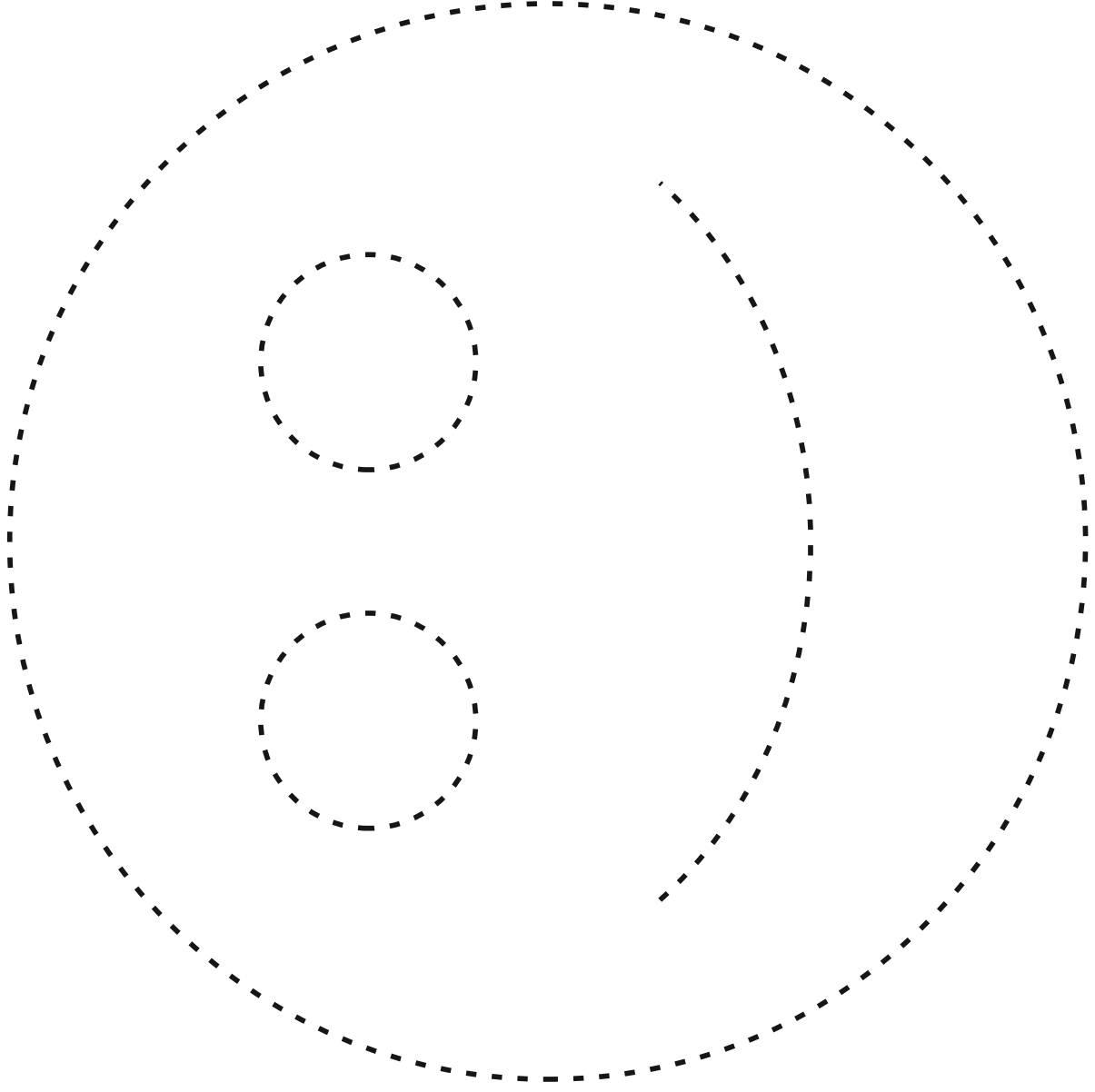

Narysuj delfina po śladzie i pokoloruj obrazek.

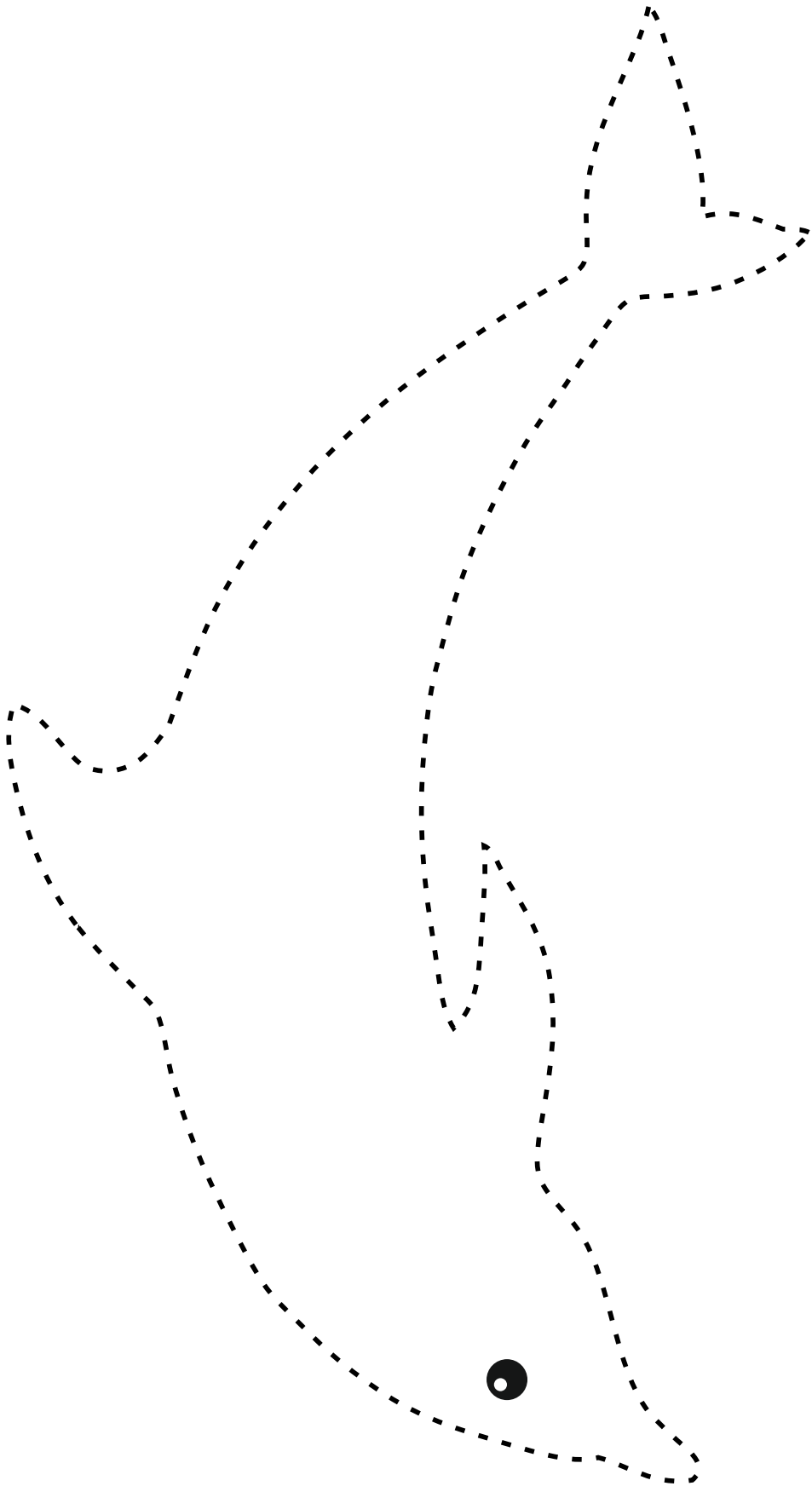

Narysuj żółwia po śladzie i pokoloruj obrazek.

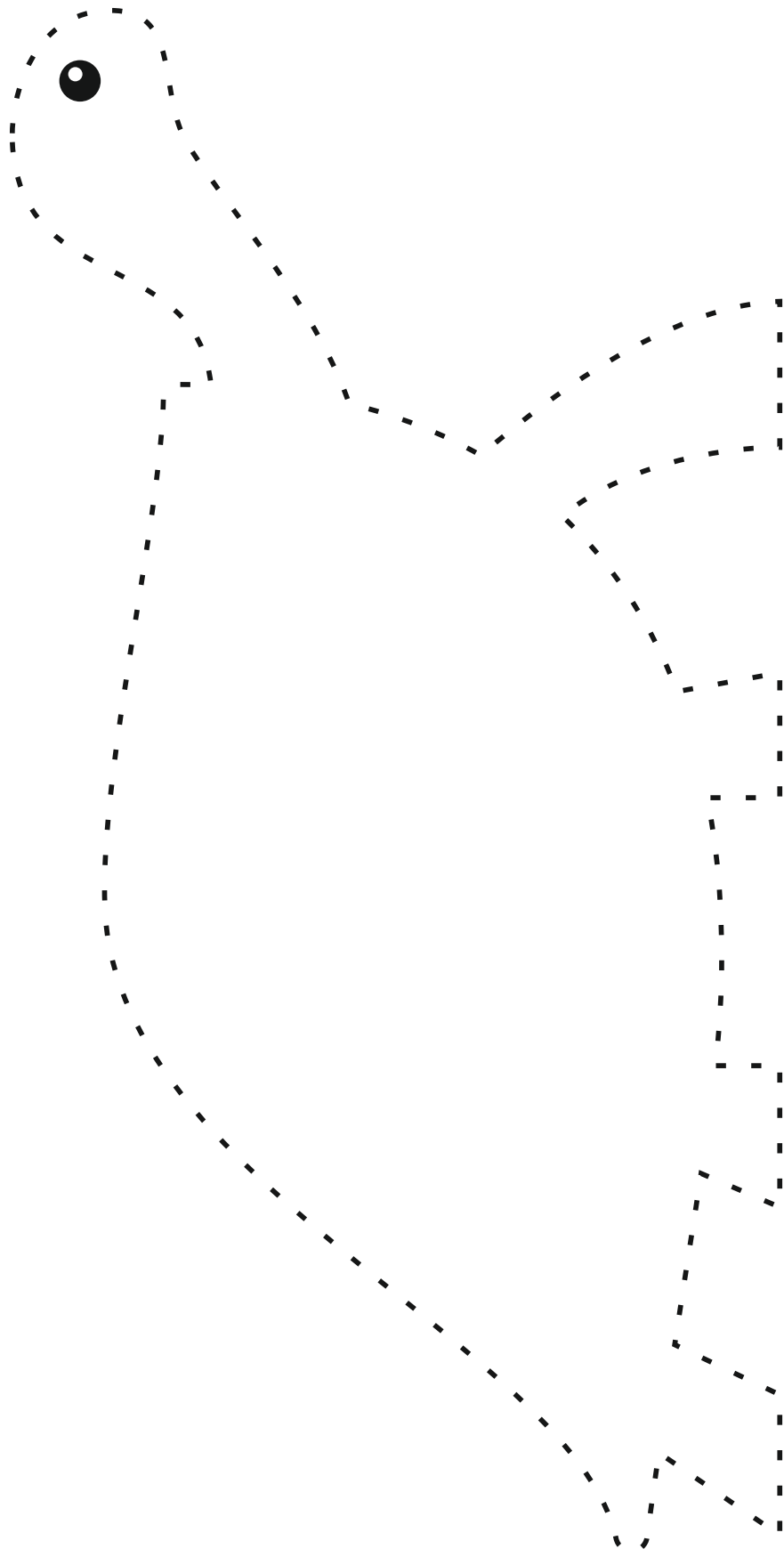

Narysuj motyla po śladzie i pokoloruj obrazek.

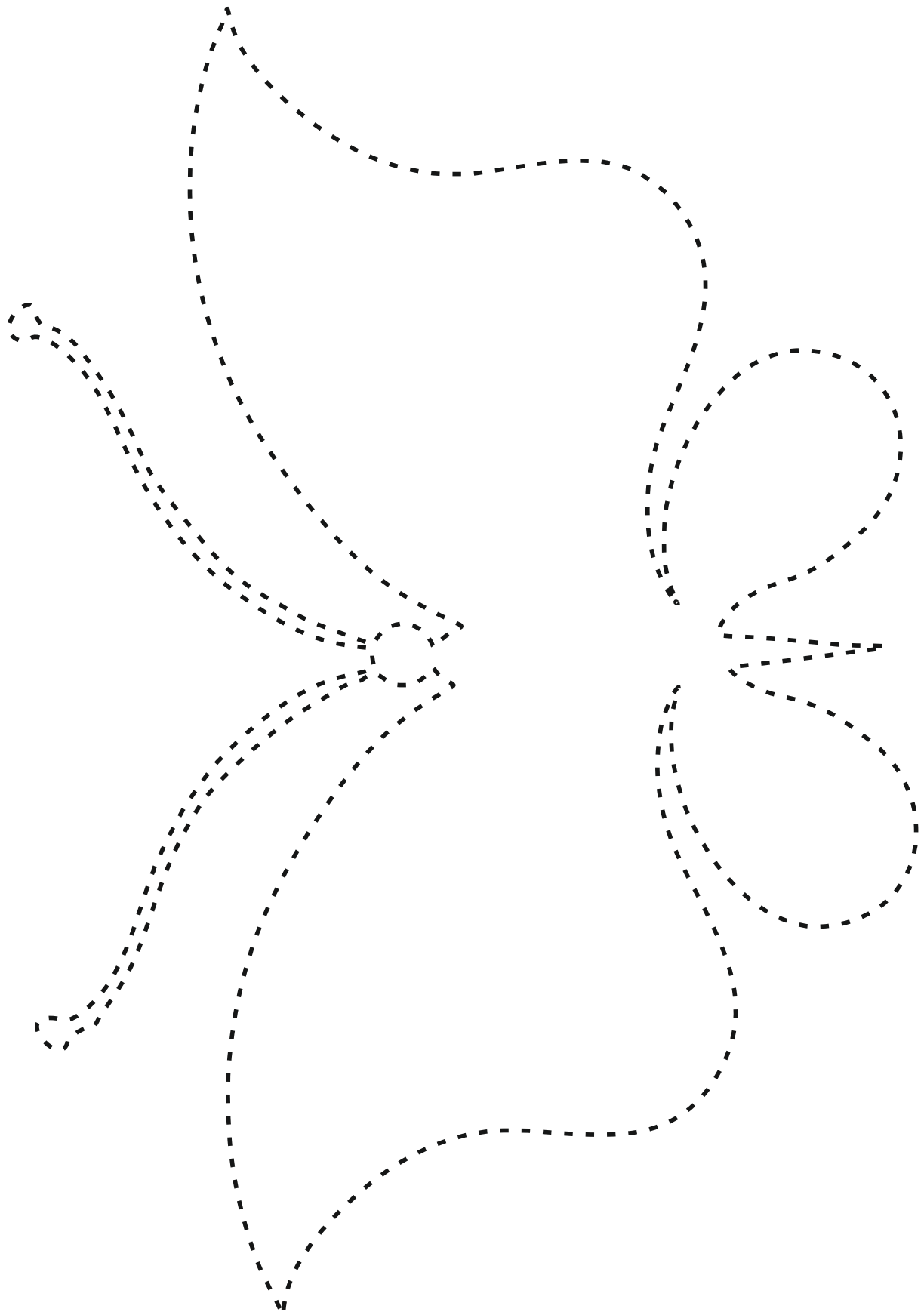

Narysuj po śladzie i pokoloruj obrazek.

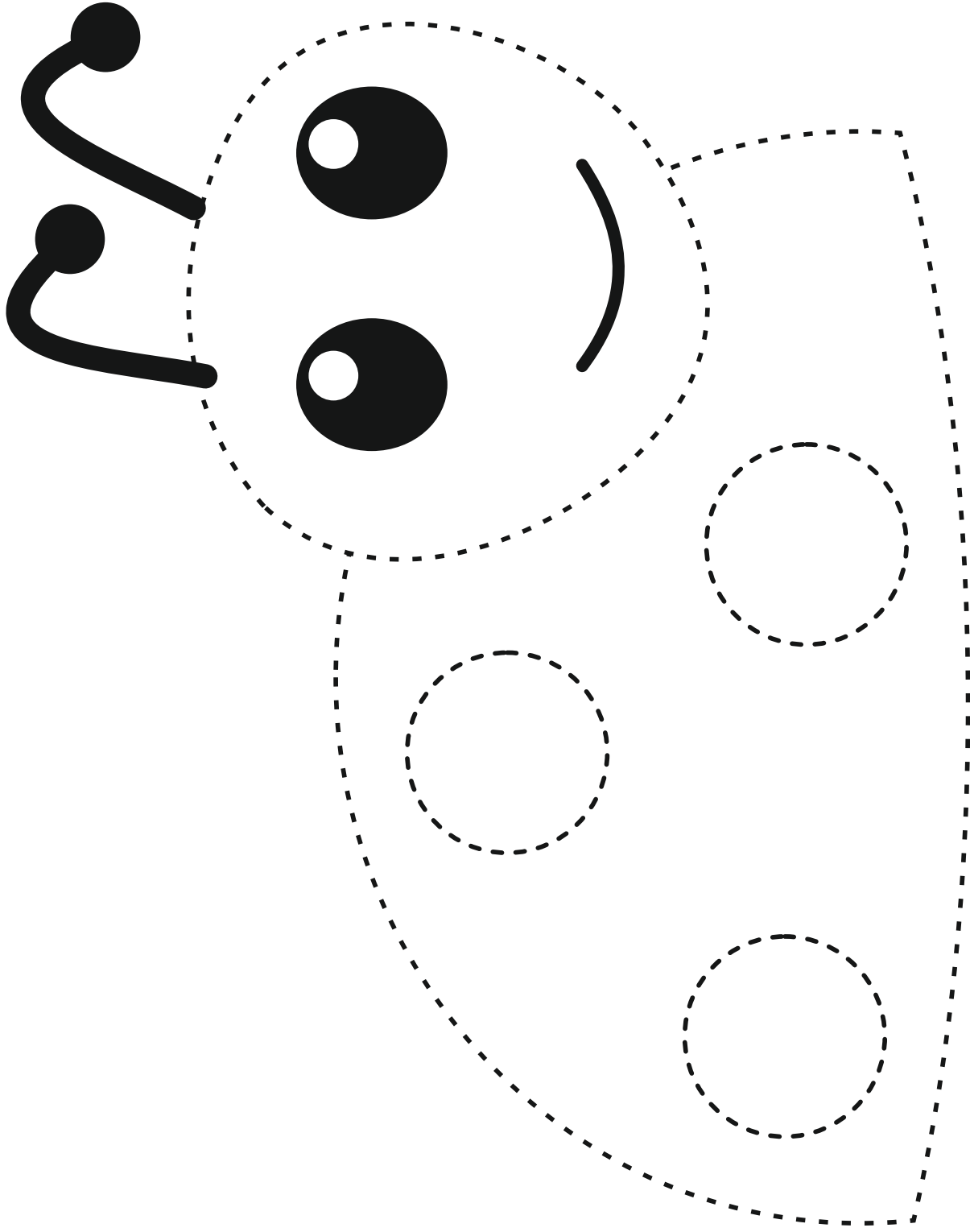

Narysuj słonia po śladzie i pokoloruj obrazek.

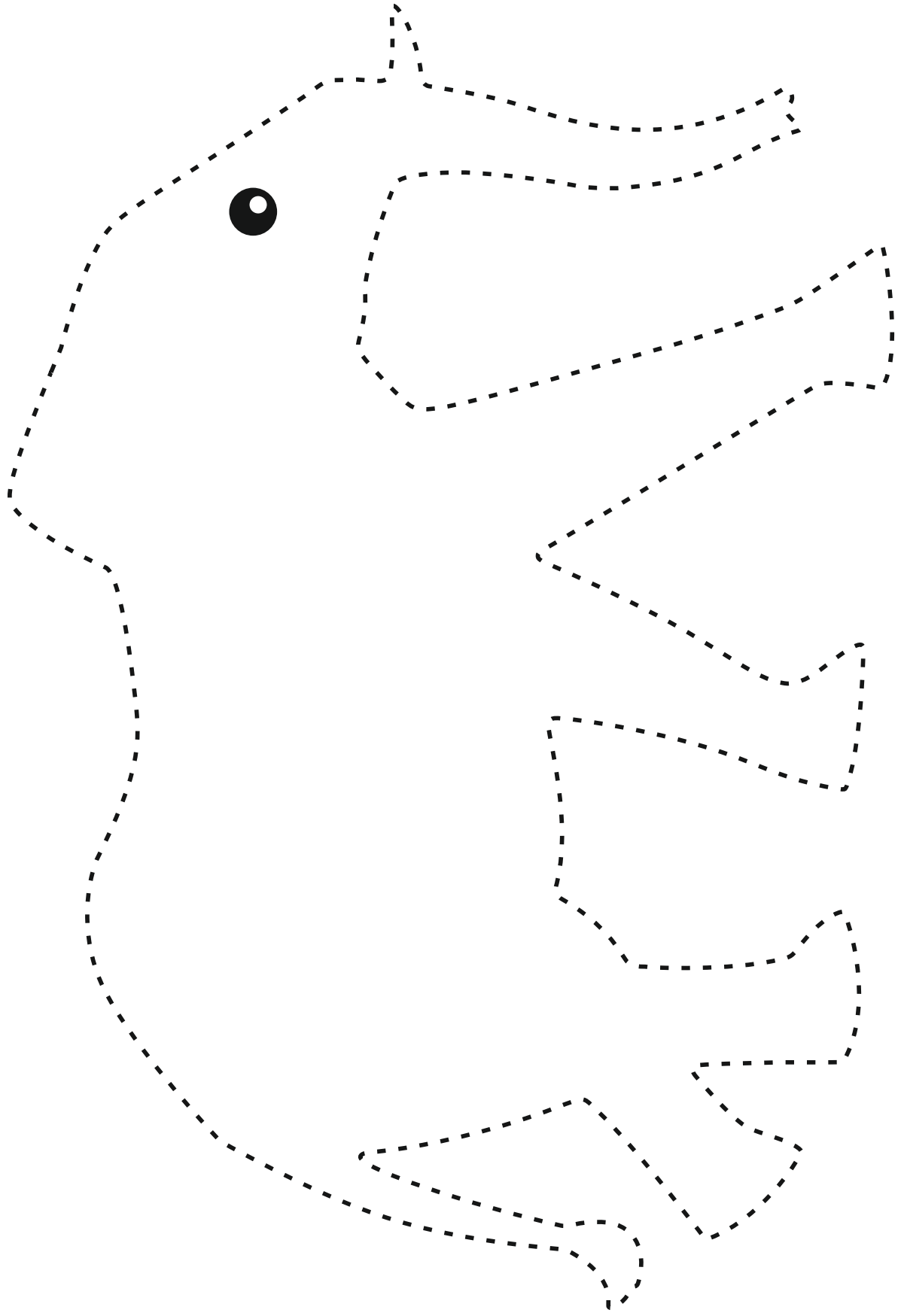

Narysuj żyrafę po śladzie, dorysuj jej łaty i pokoloruj obrazek.

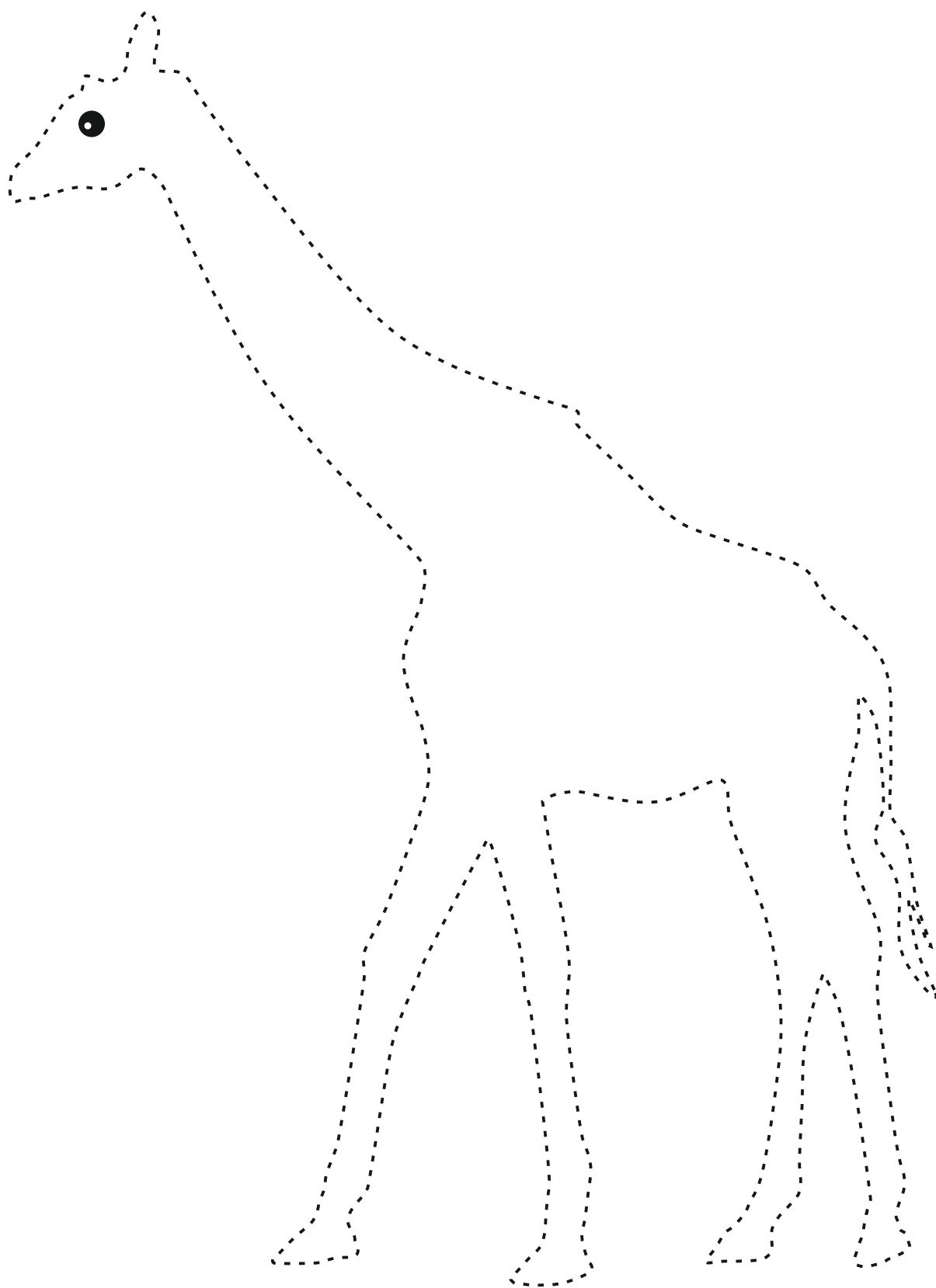

Narysuj węża po śladzie i pokoloruj obrazek.

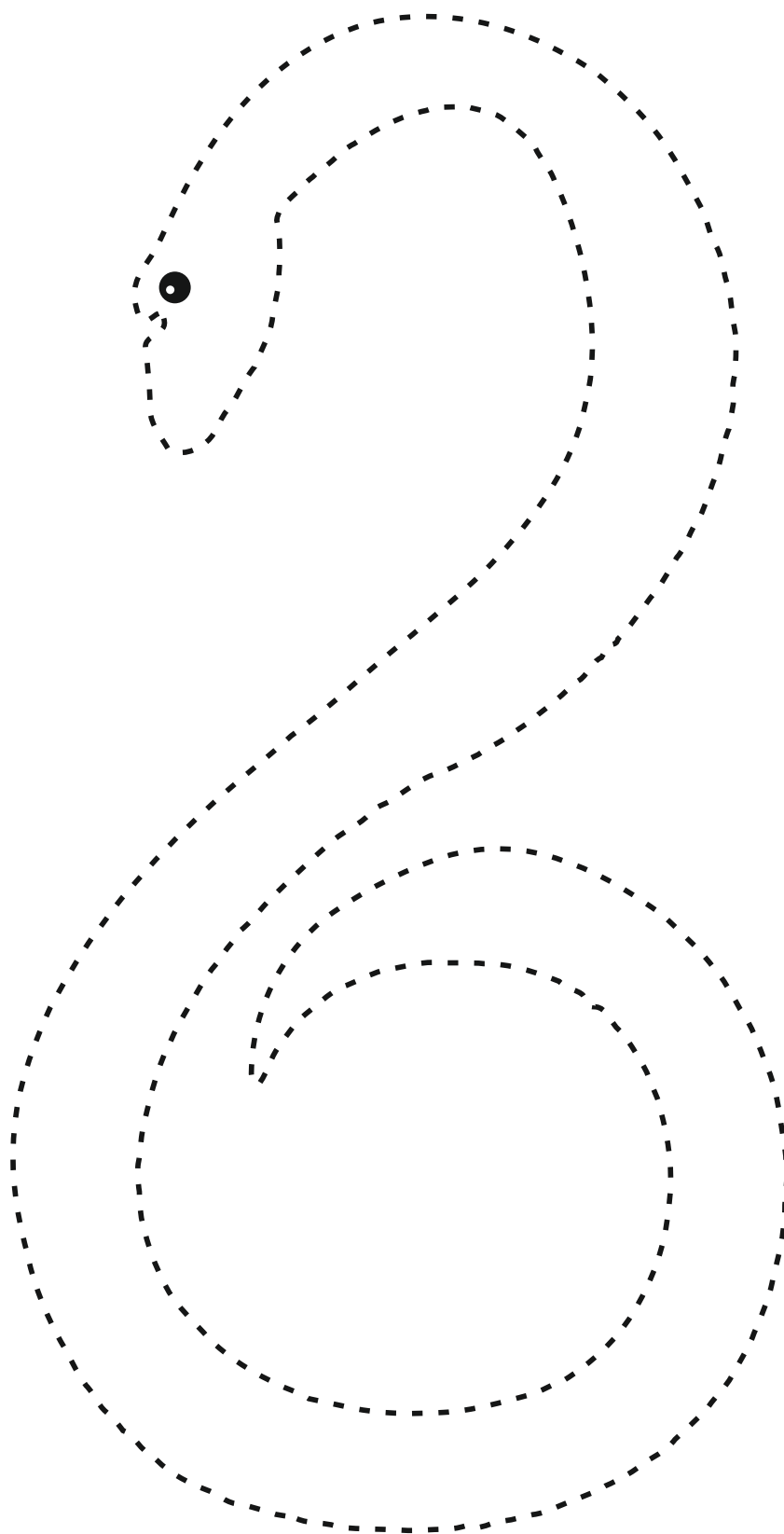

Narysuj żaglówkę po śladzie i pokoloruj obrazek.

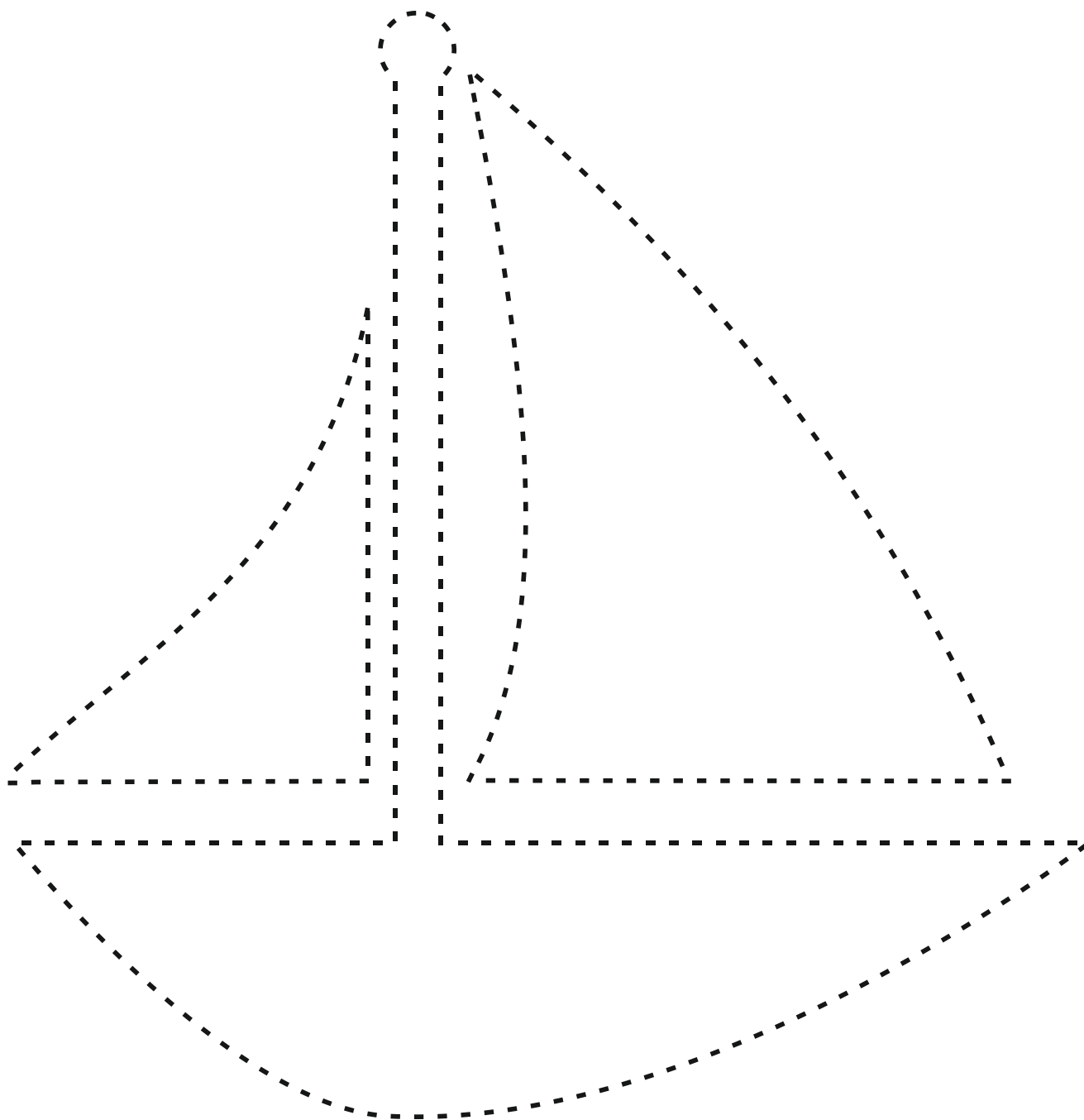

Narysuj muszelkę po śladzie i pokoloruj obrazek.

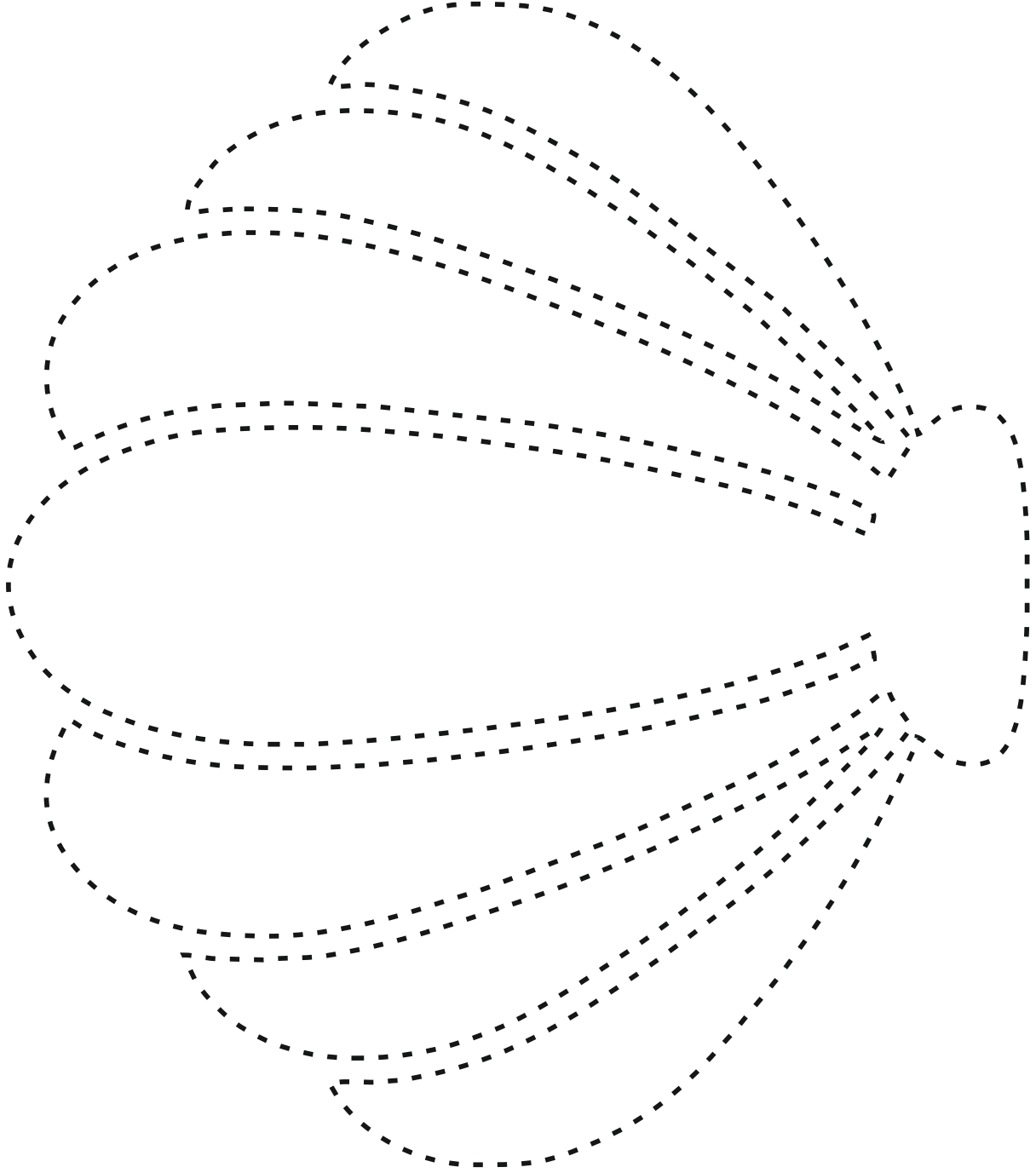

Narysuj po śladzie i pokoloruj obrazek.

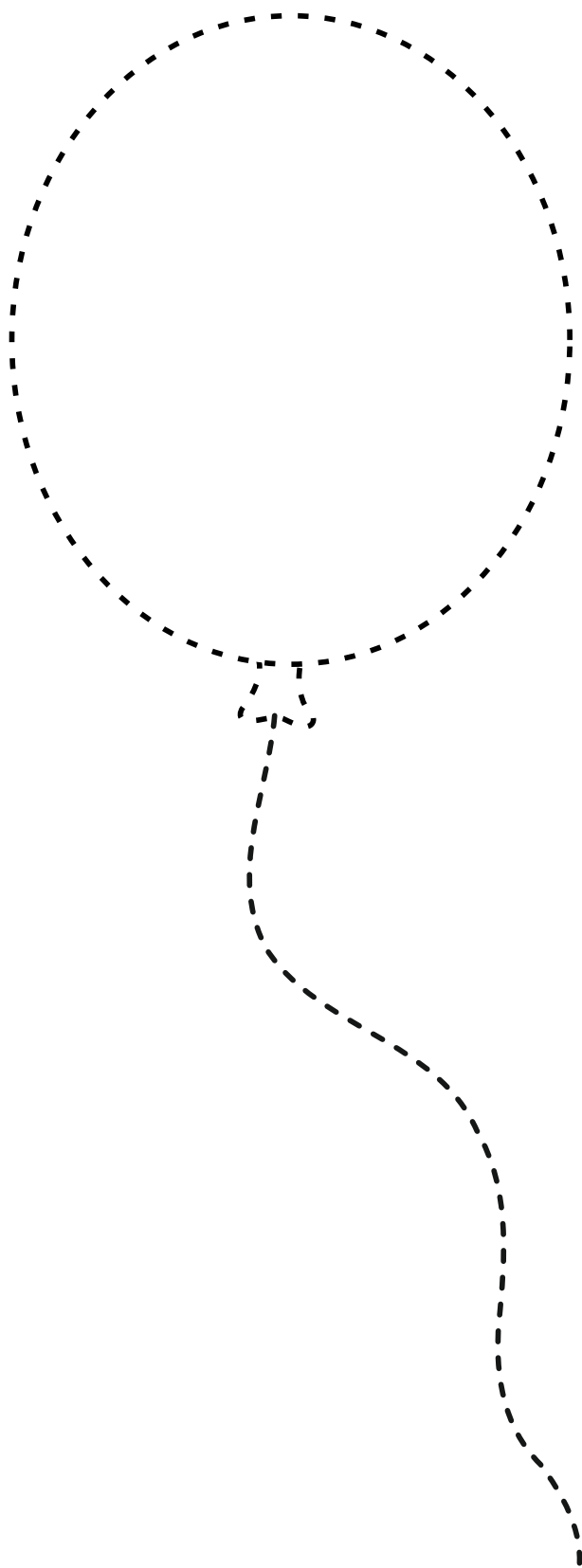

Narysuj jabłko po śladzie, a następnie wyklej plasteliną.

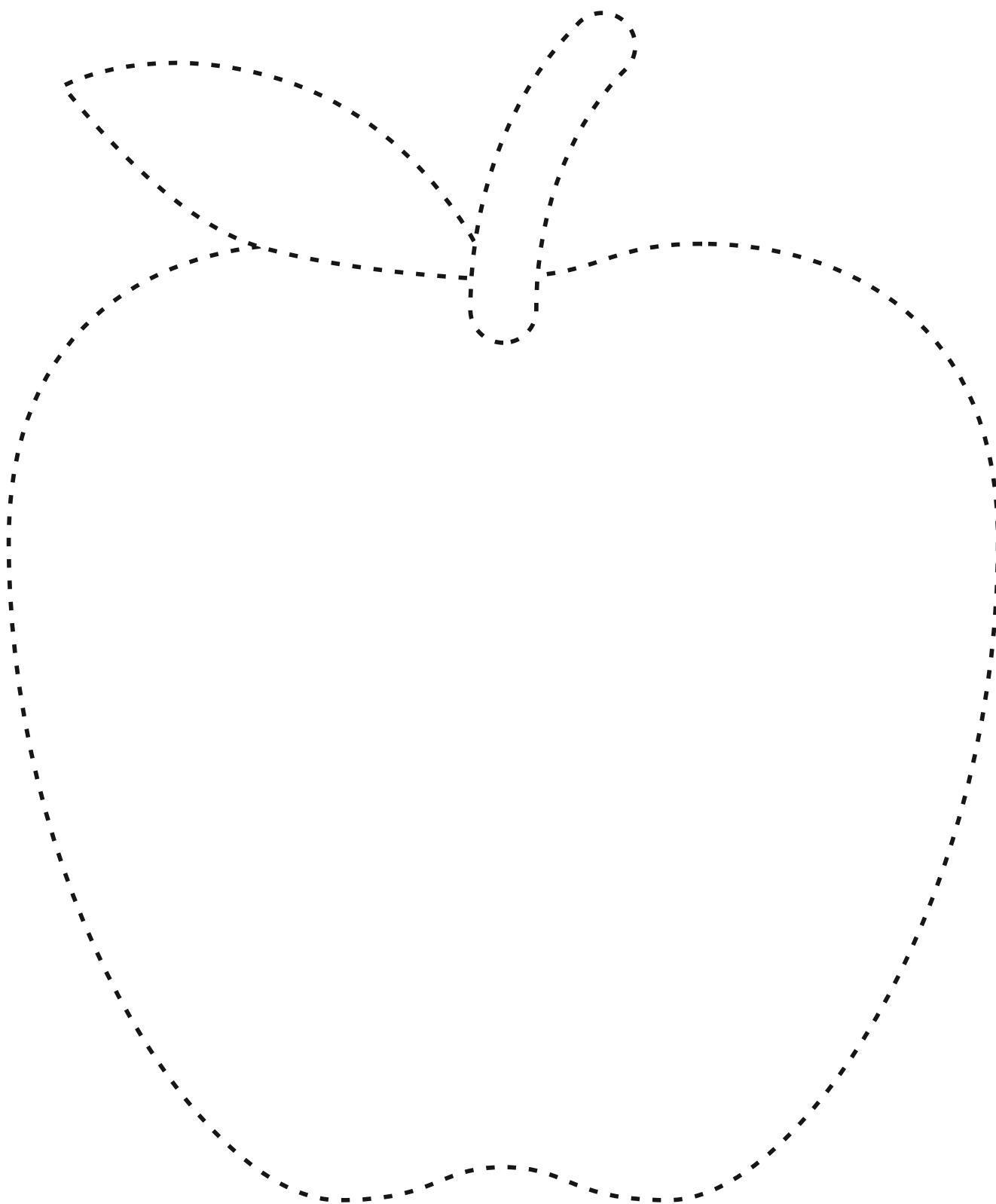

Narysuj banana po śladzie, a następnie wyklej plasteliną.

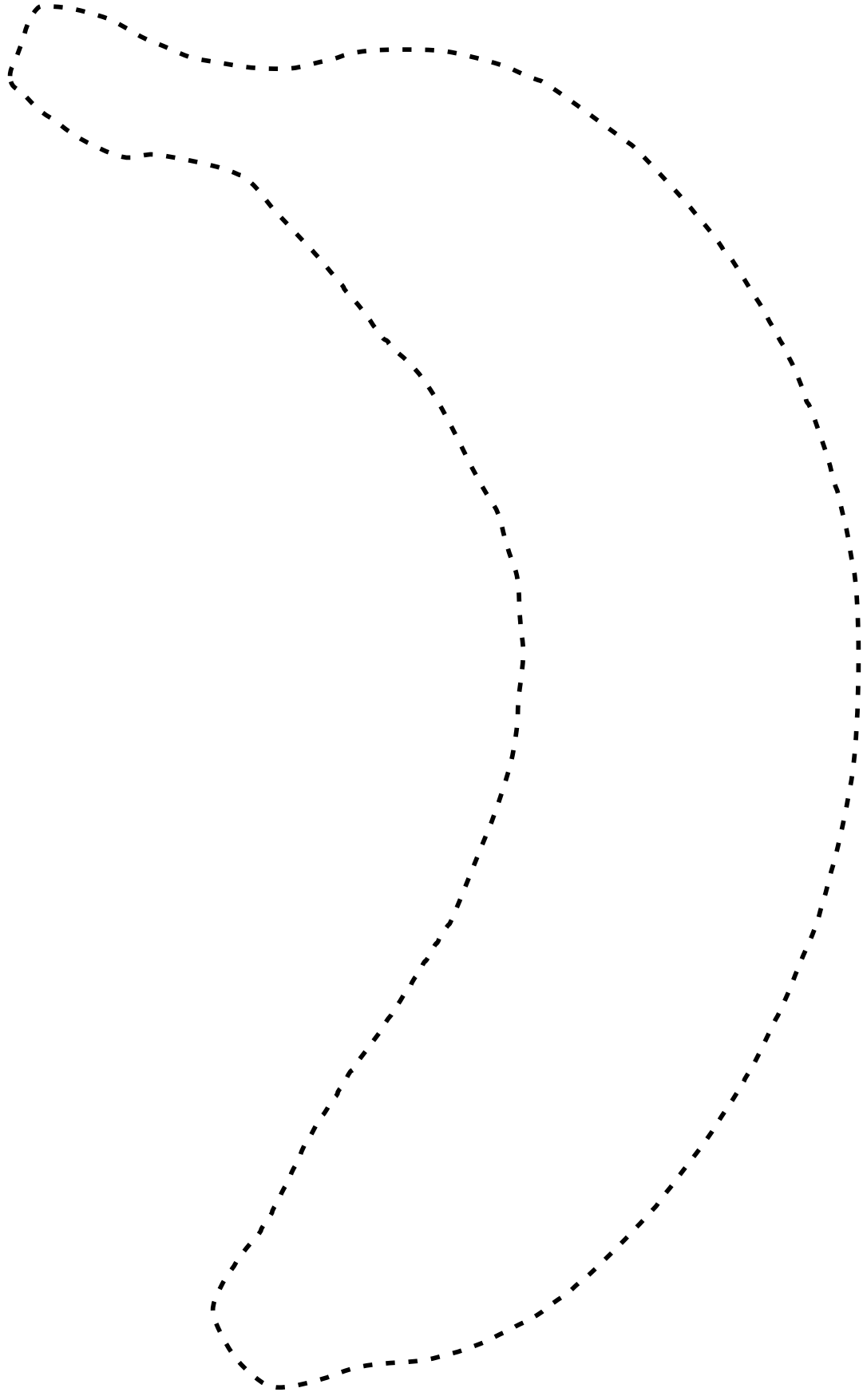

Narysuj gruszkę po śladzie, a następnie pomaluj farbami.

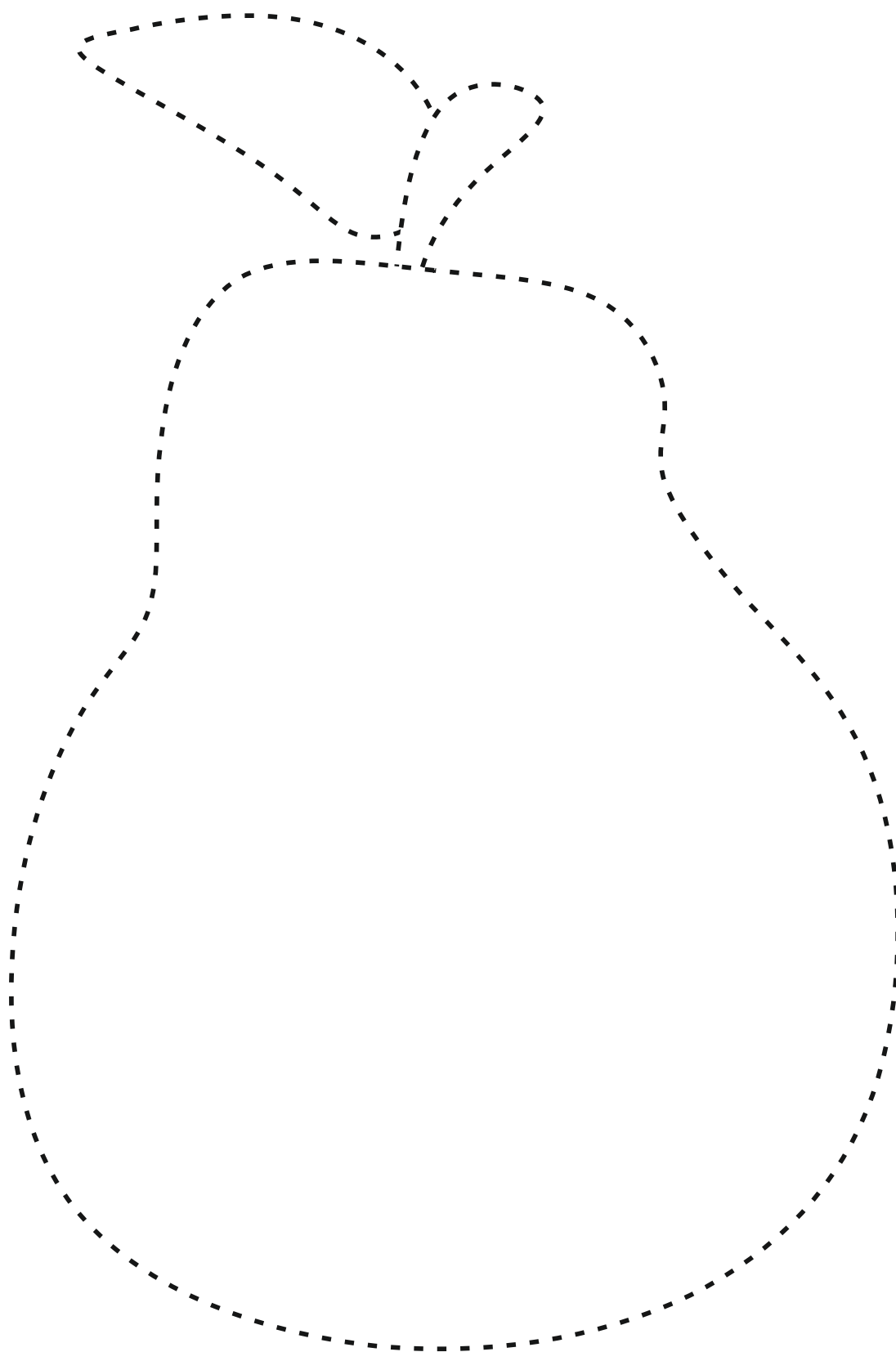

Poprowadź linie wewnątrz wzoru i pomóż pszczołce dolecieć na kwiatek.

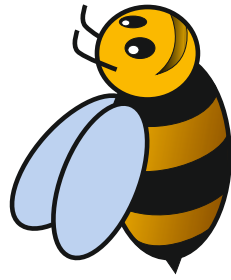
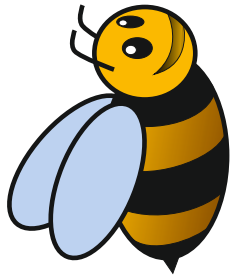
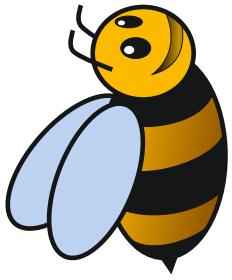
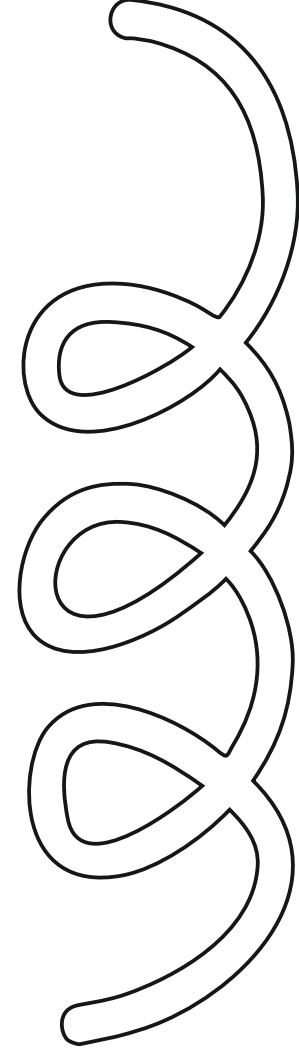
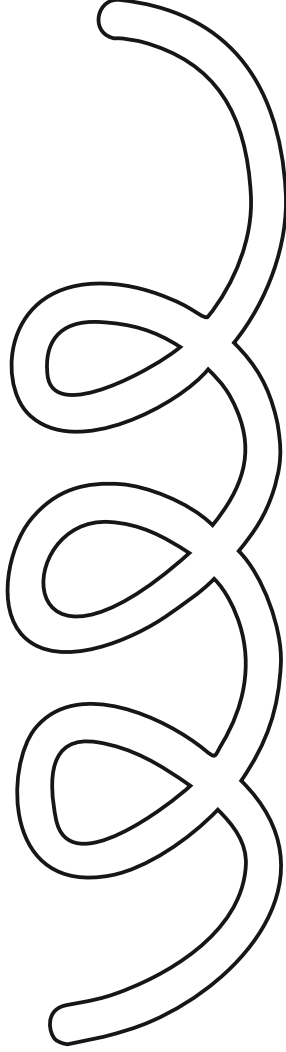
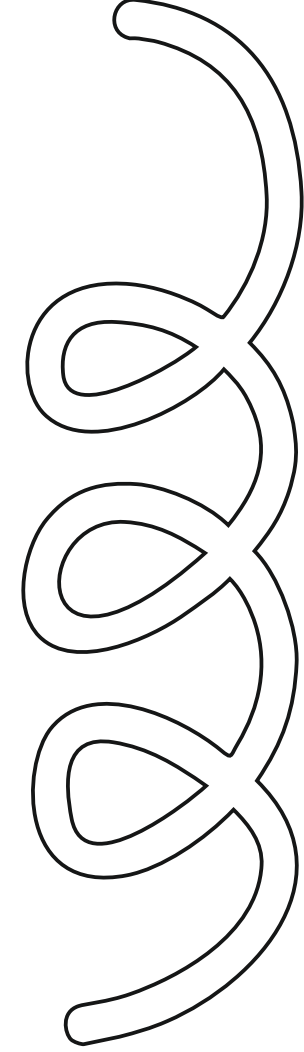
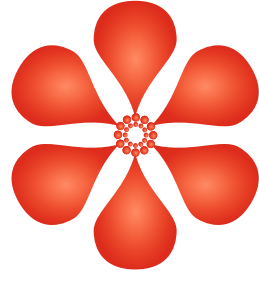
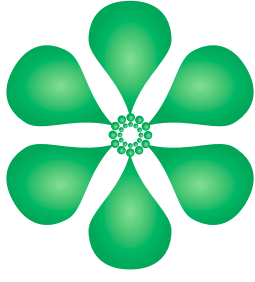
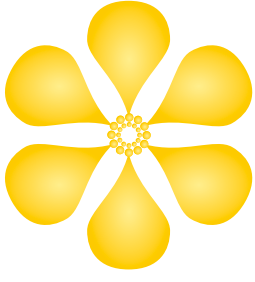

Pokoloruj kwiatki według kolorów z przedstawionej legendy.

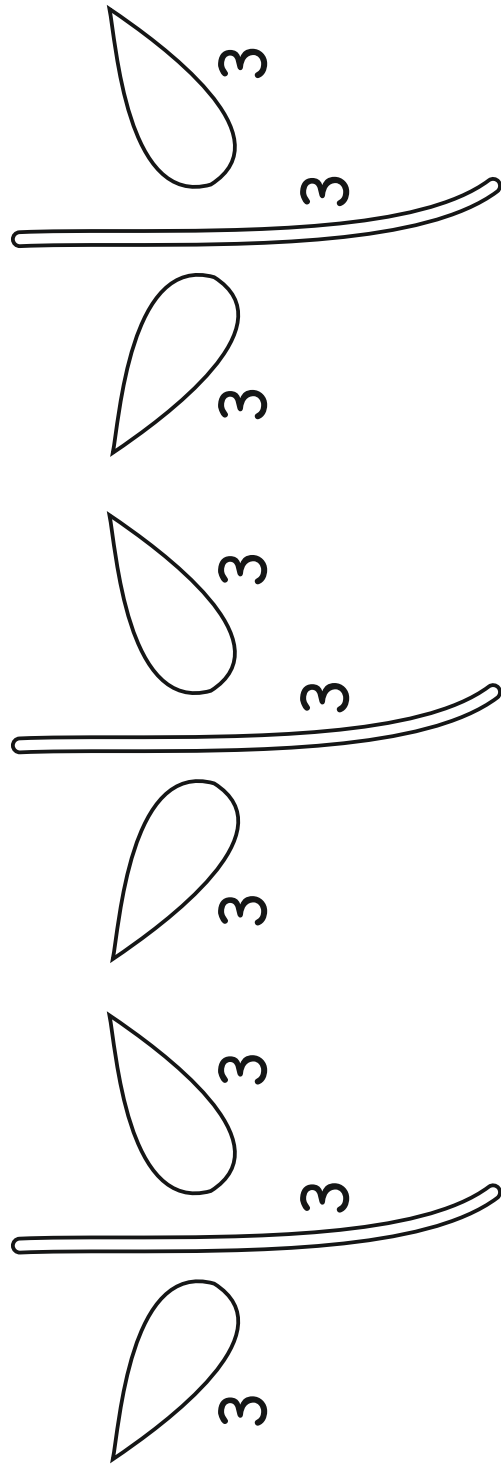
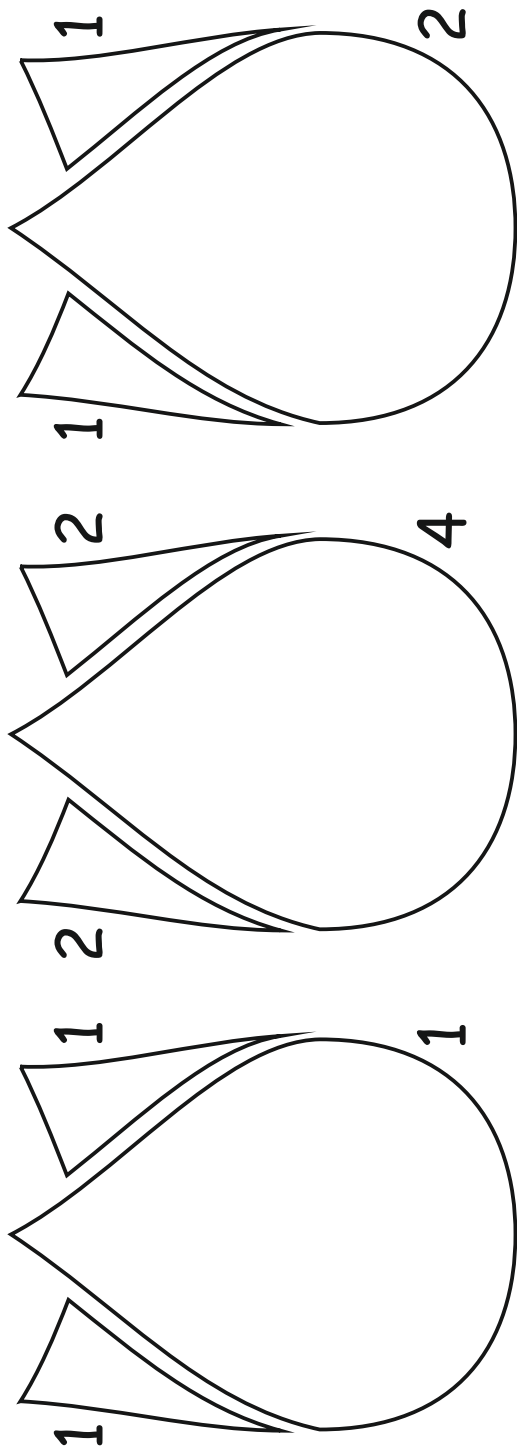
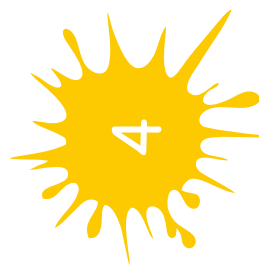
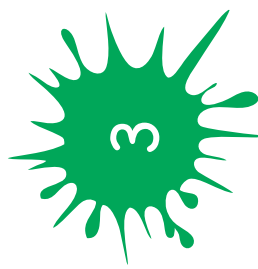
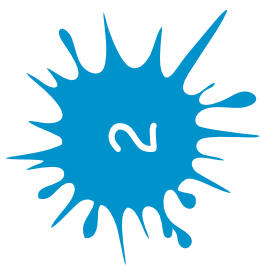

Narysuj po śladzie i pokoloruj obrazki.

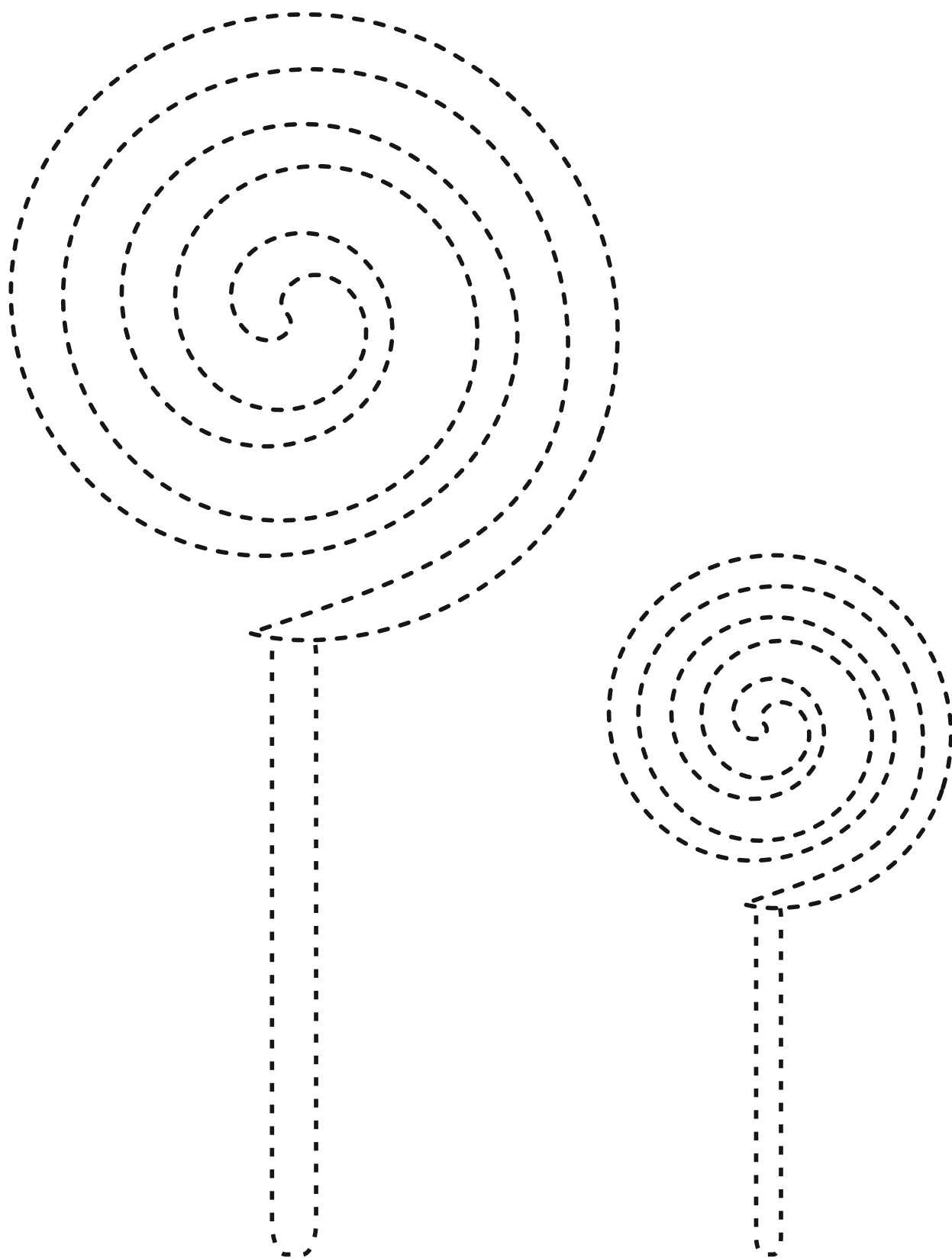

Narysuj po śladzie i pokoloruj obrazek.

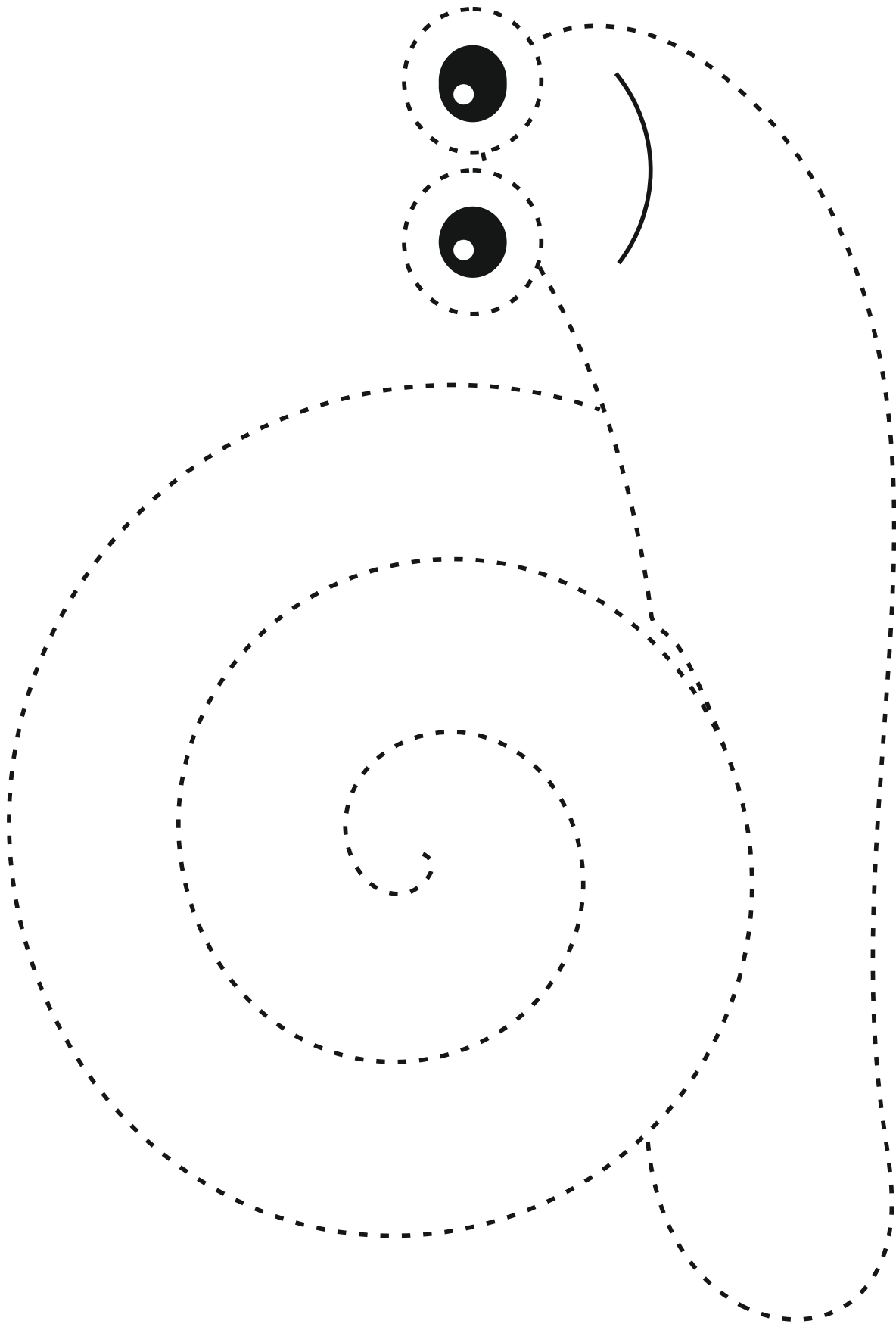

Narysuj po śladzie i pokoloruj obrazek.

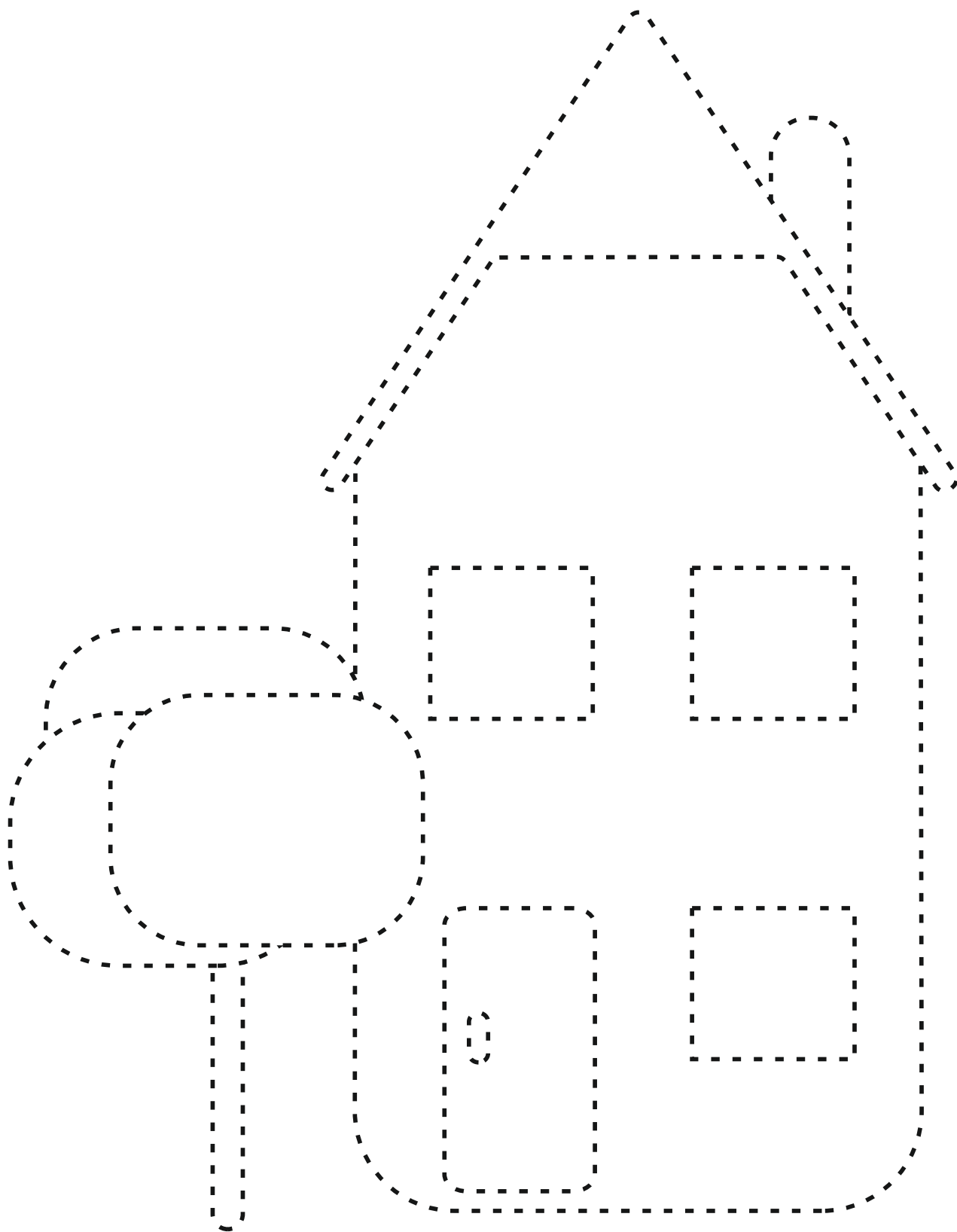

Narysuj po śladzie i pokoloruj obrazek.

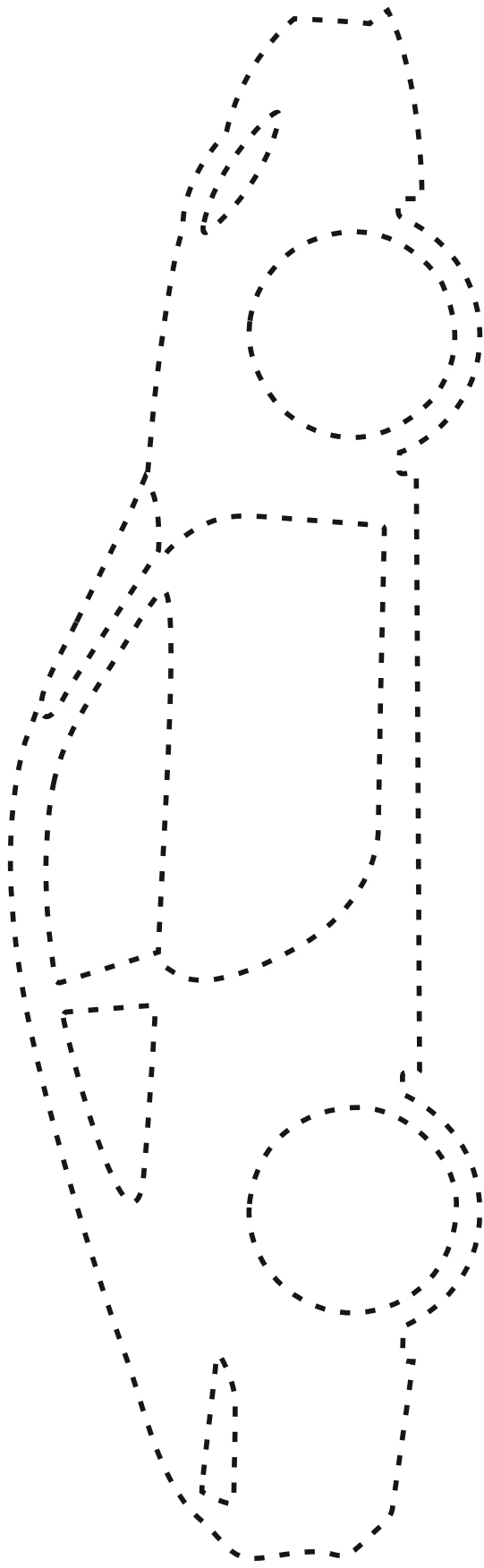

Narysuj po śladzie i pokoloruj obrazek.

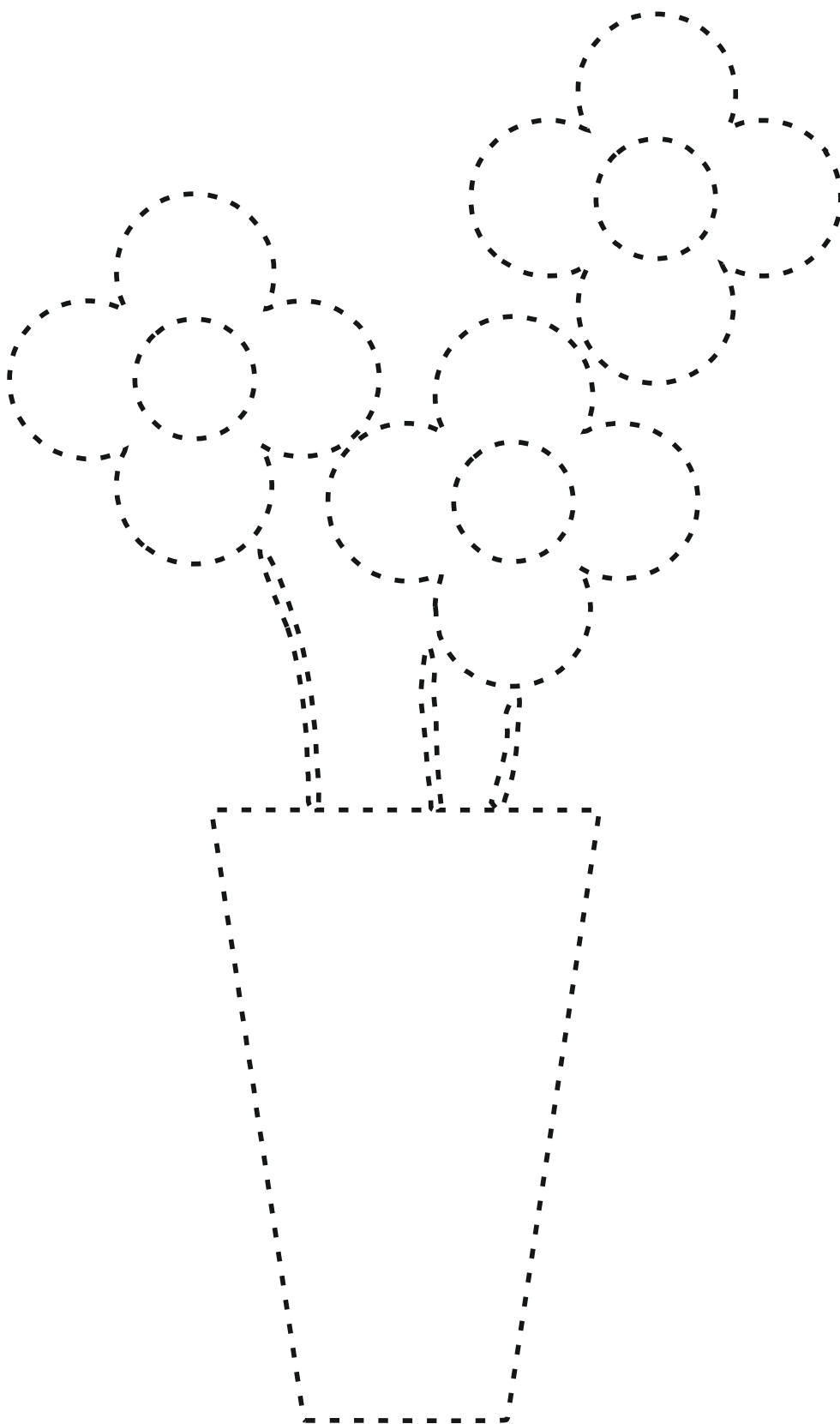

Narysuj po śladzie i pokoloruj obrazki.

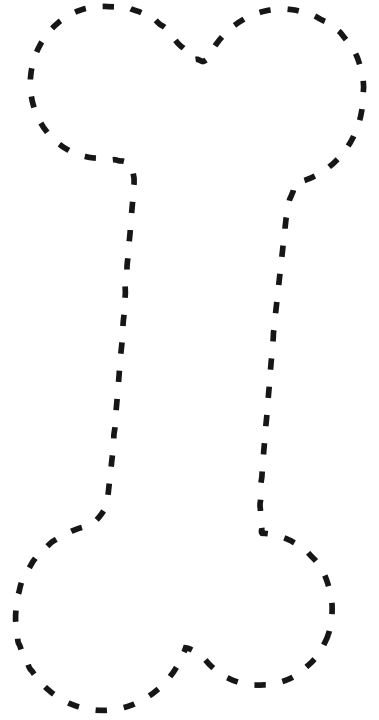
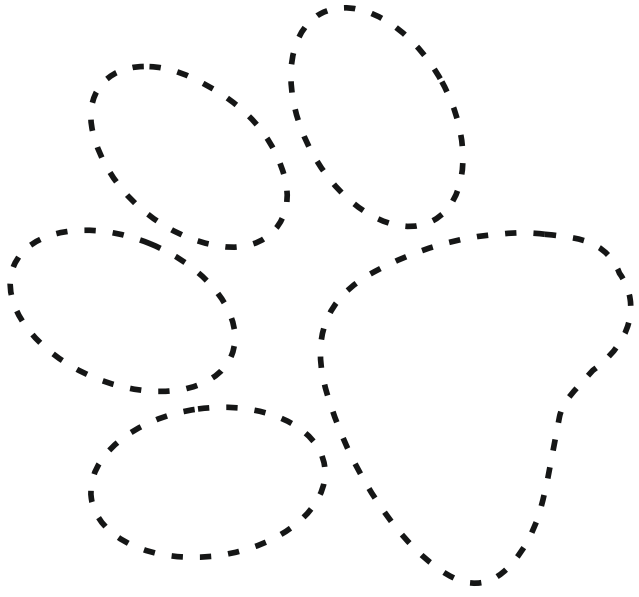
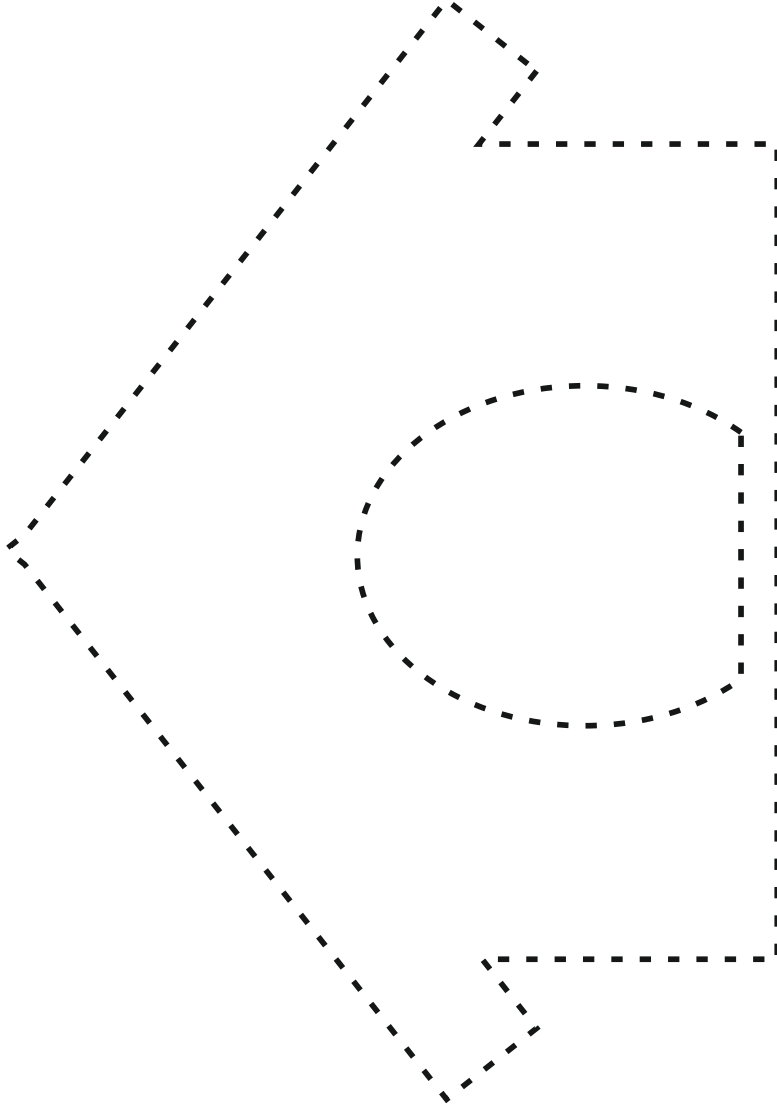

WRZESIEŃ

Narysuj po śladzie, a następnie pokoloruj powstałą postać z bajki.

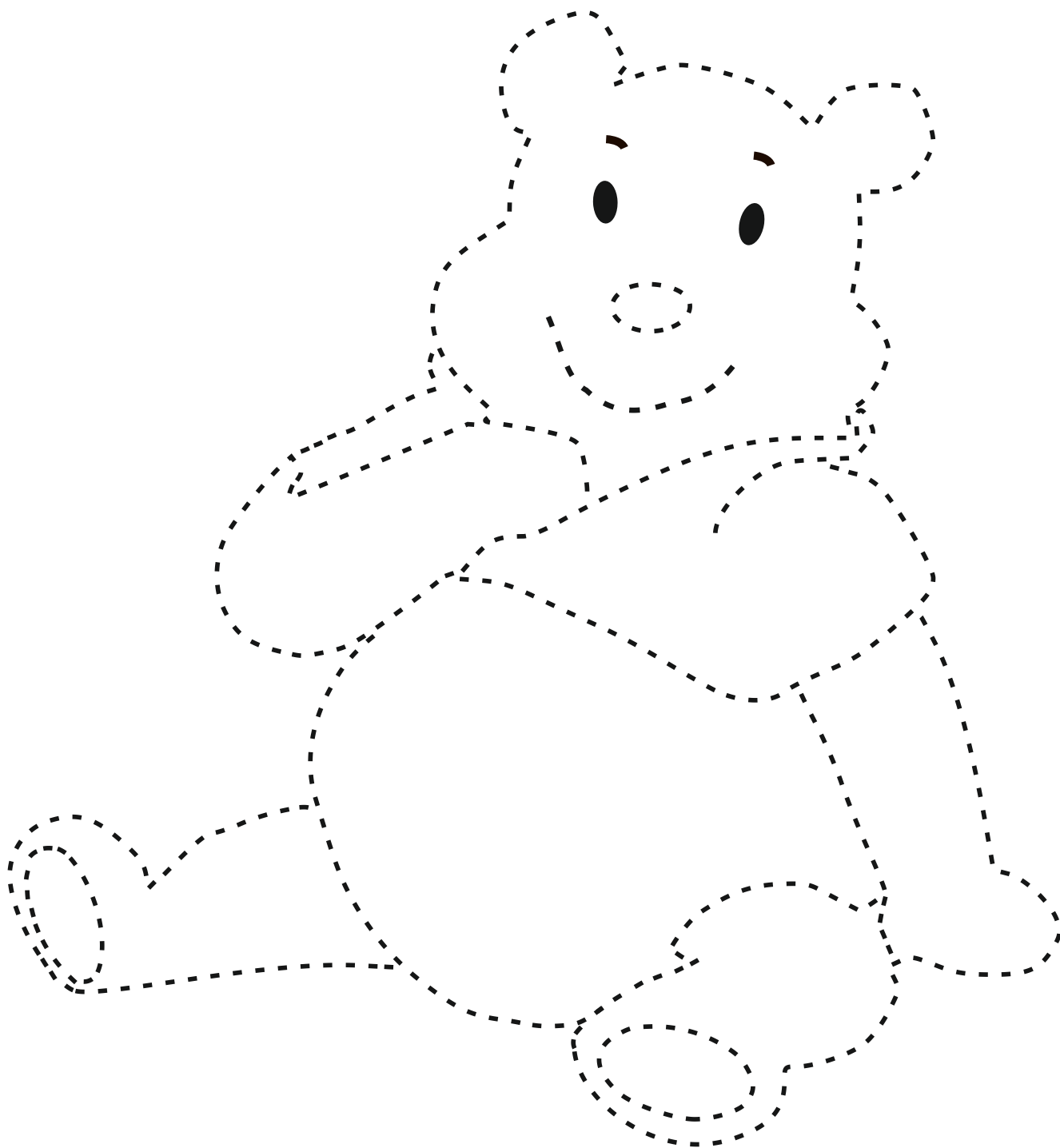

Narysuj po śladzie, a następnie pokoloruj powstałą postać z bajki.

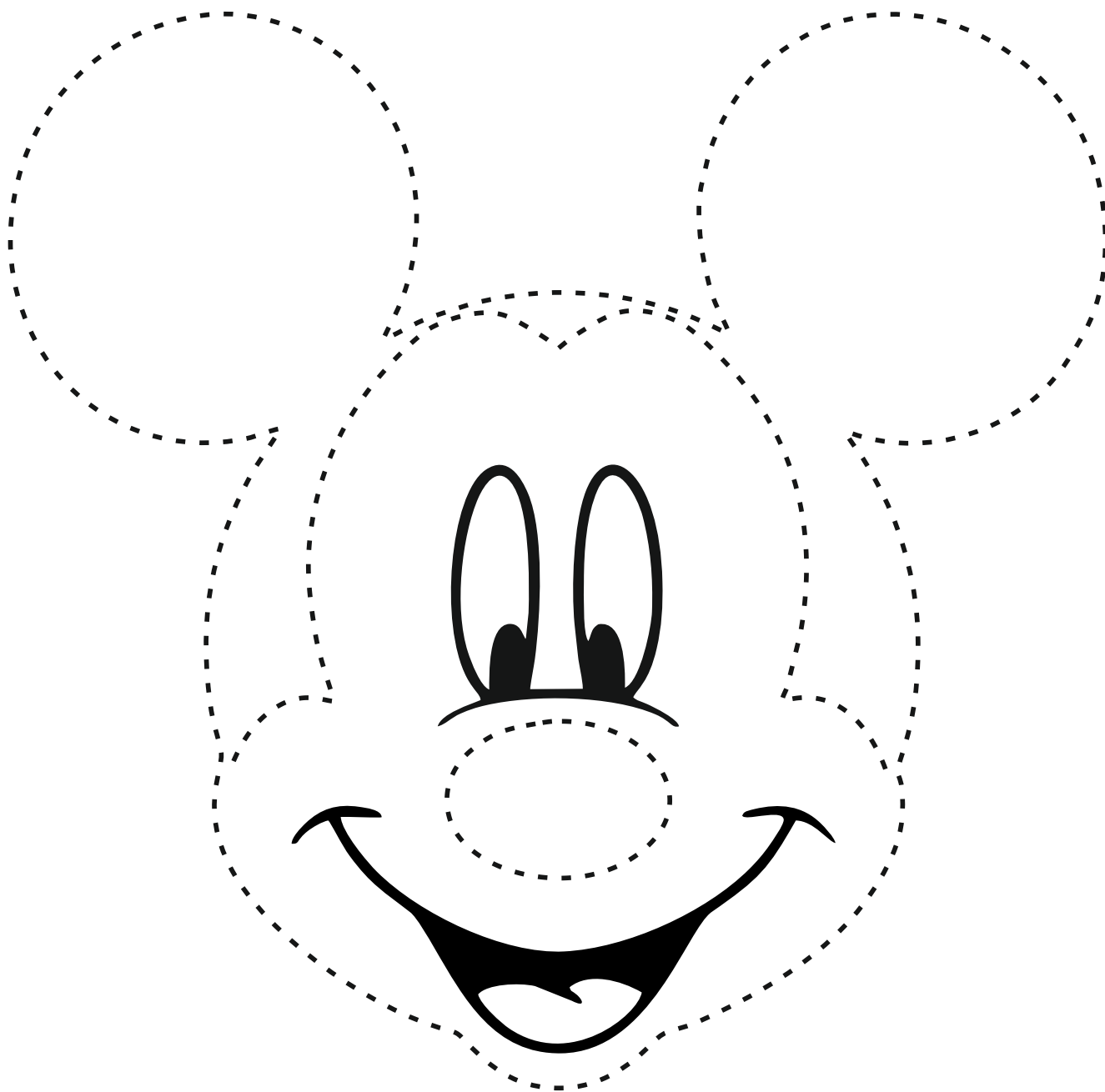

Narysuj linie po śladzie i doprowadź Scooby-Doo do kości.

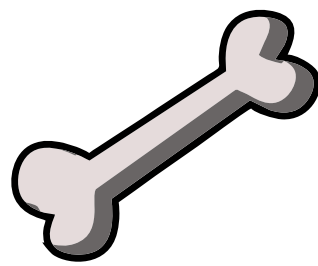
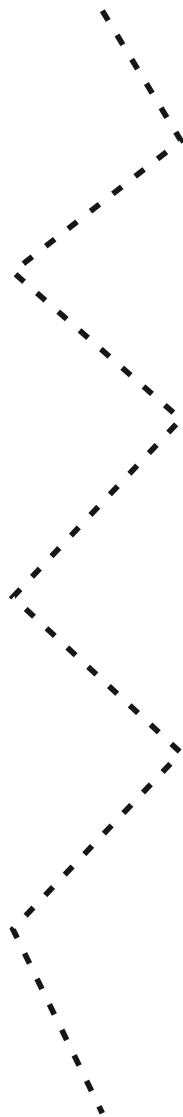
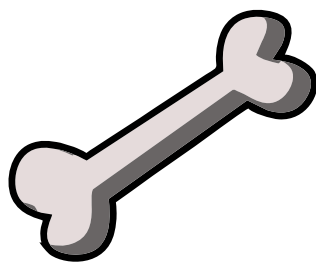
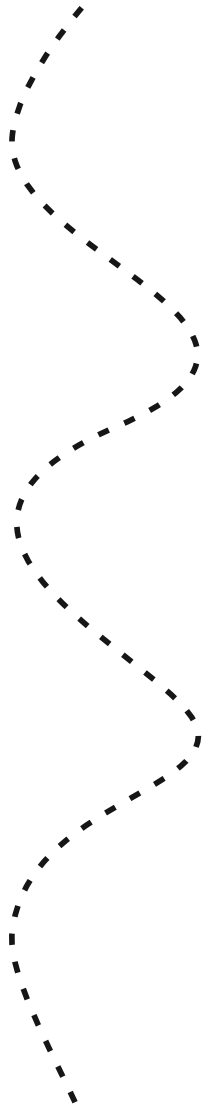
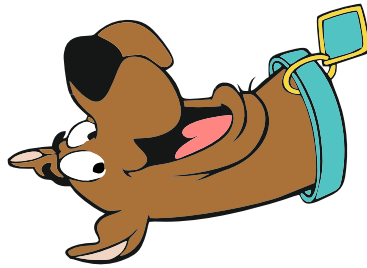
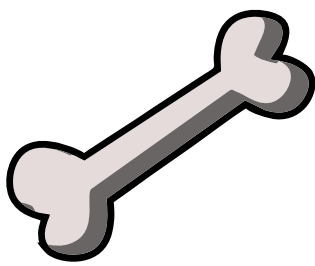

Narysuj żółdzia po śladzie, a następnie pomaluj farbami.

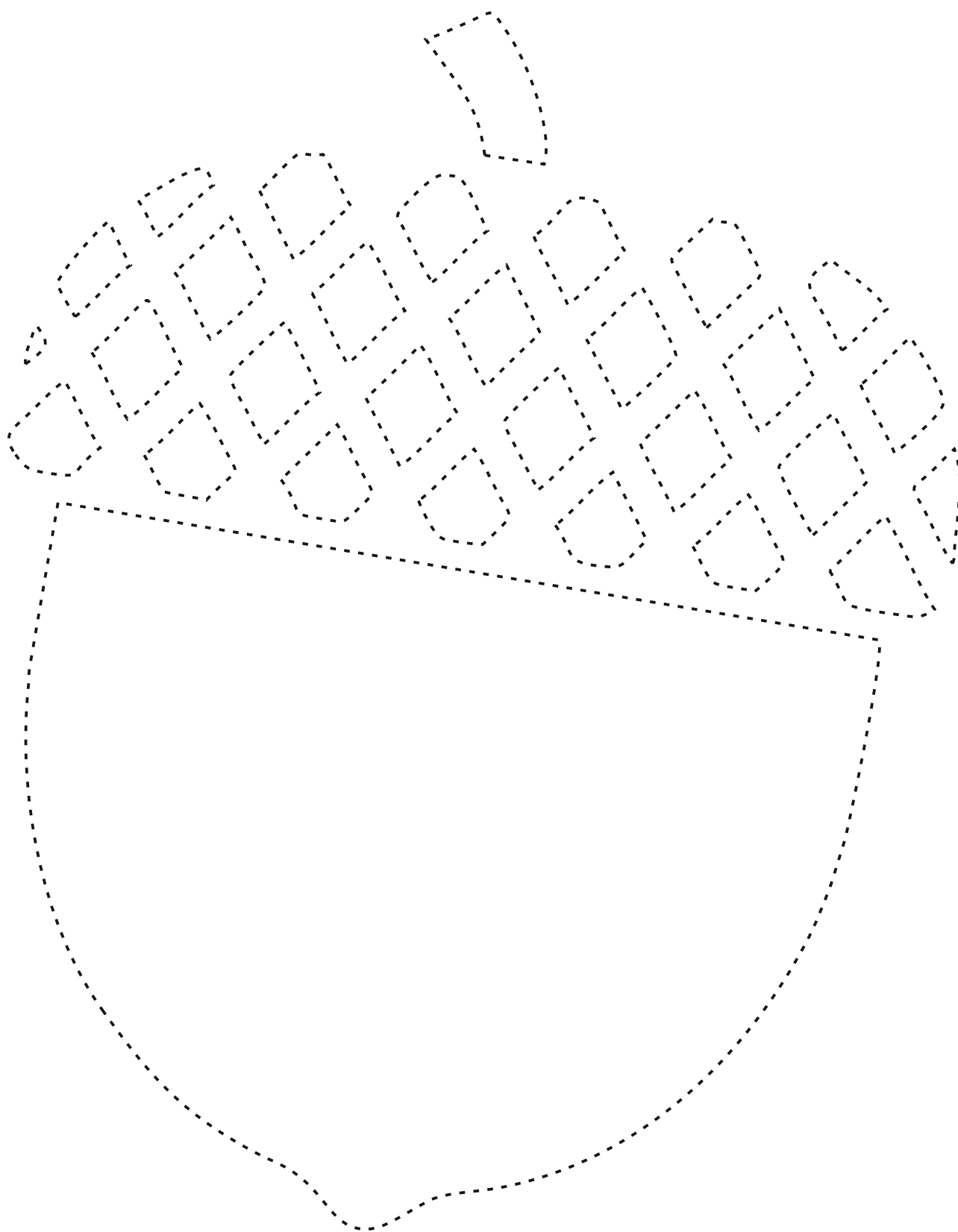

Odrysuj chmurki po śladzie, a następnie narysuj w nich swoje marzenia.

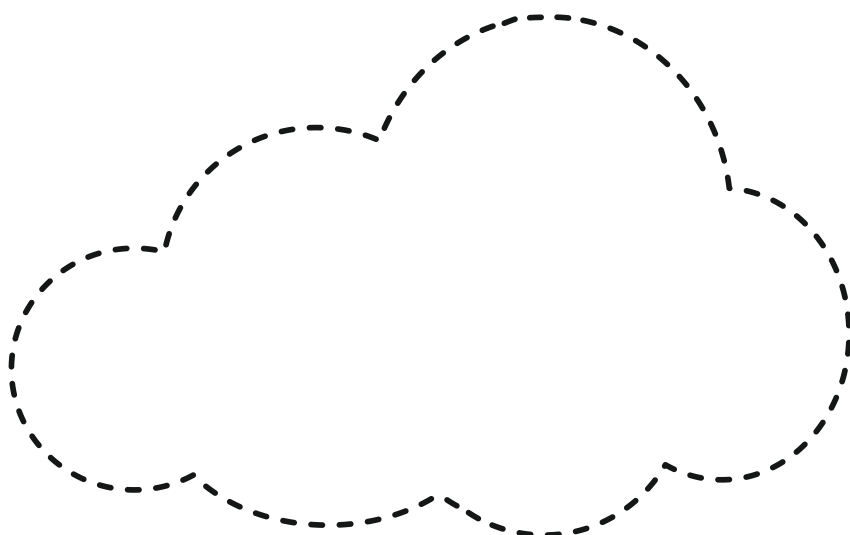

Narysuj linie po śladzie i dowiedz się o czym marzą dzieci.

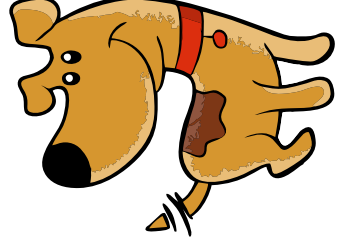
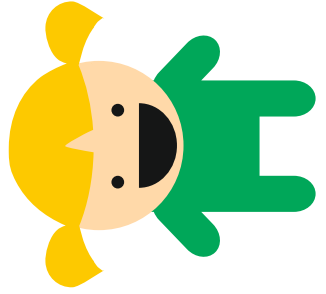
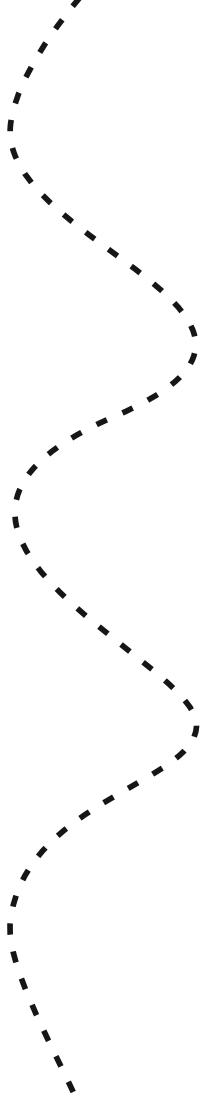
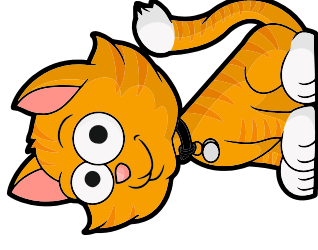
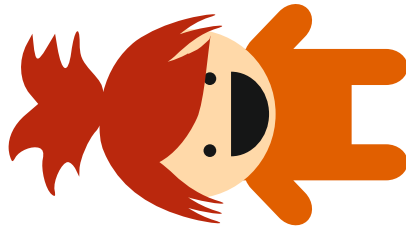
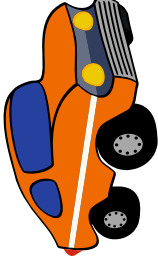
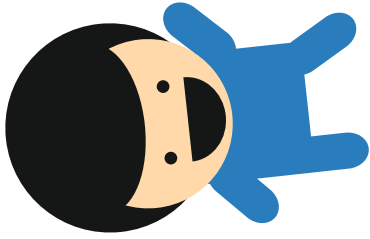

Każdy przedszkolak powinien mieć kredki. Stwórz swoje!

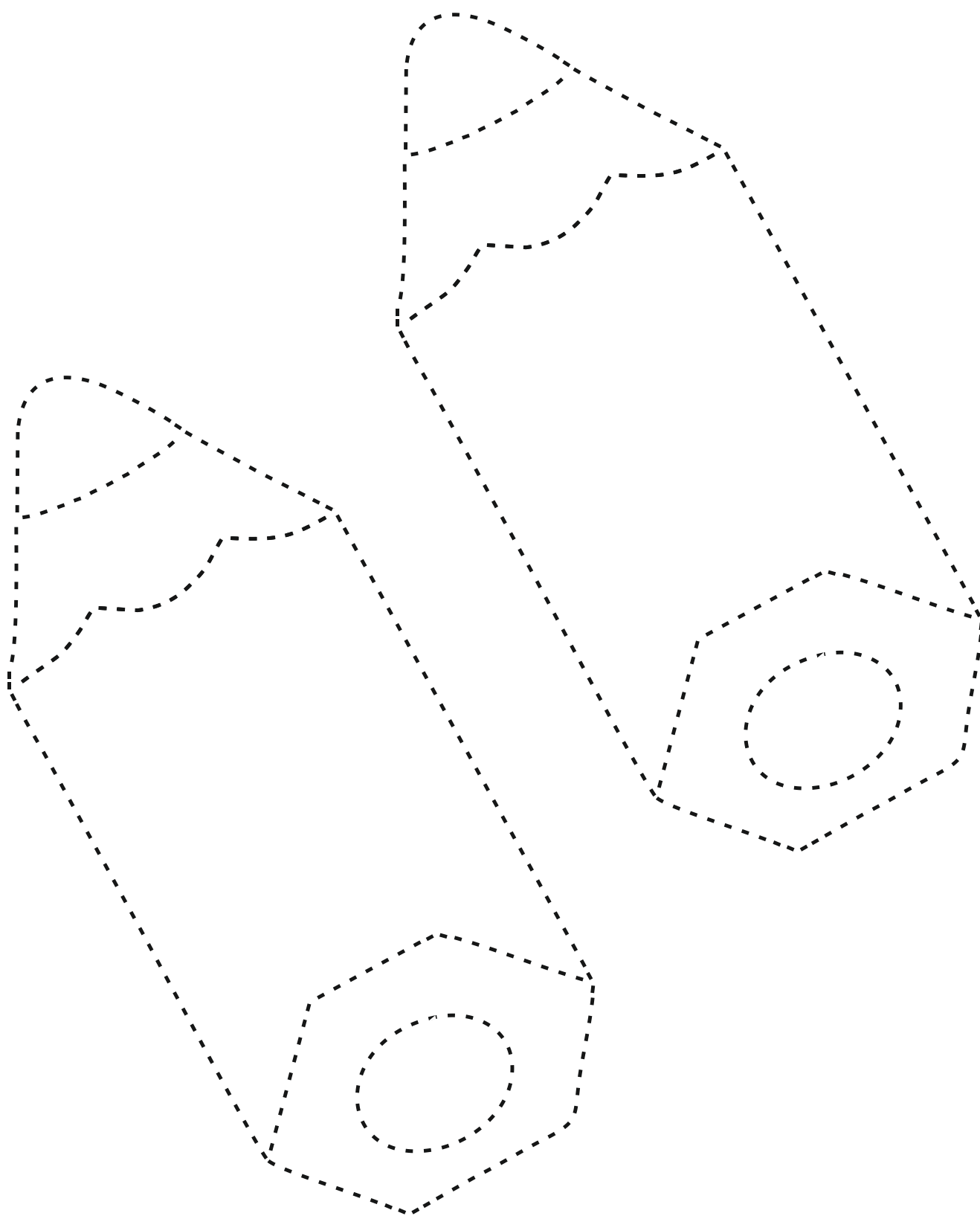

PAŹDZIERNIK

Narysuj po śladzie, a następnie pomaluj farbami.

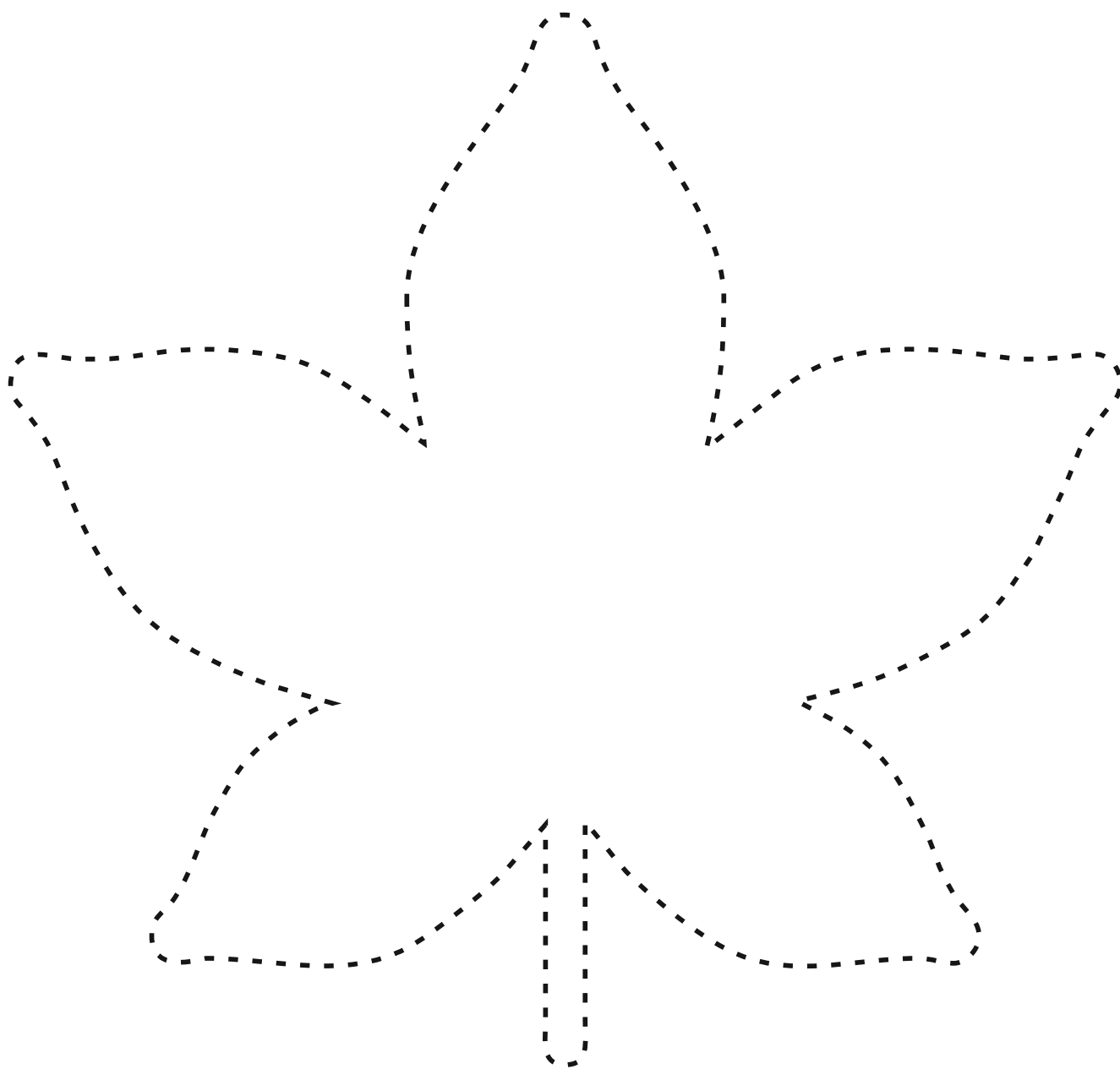

Narysuj po śladzie i poznaj zwierzęta domowe.

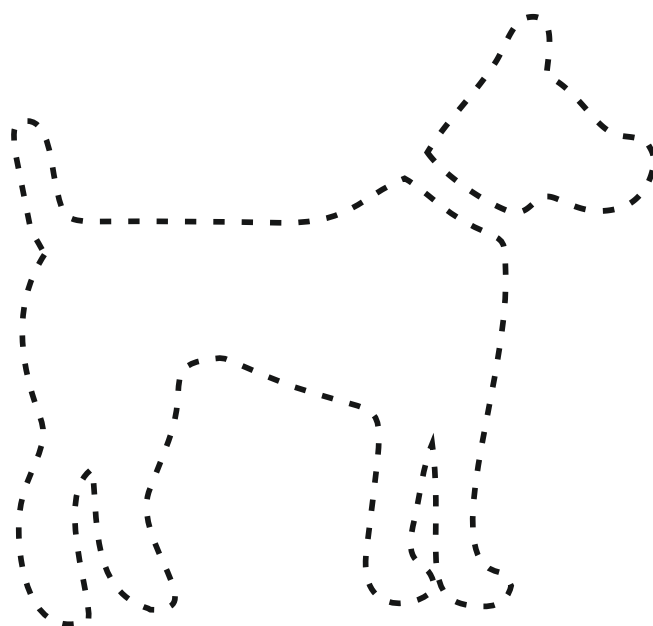
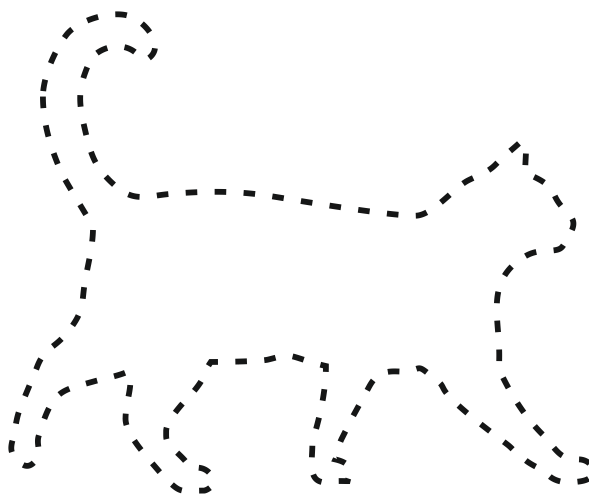
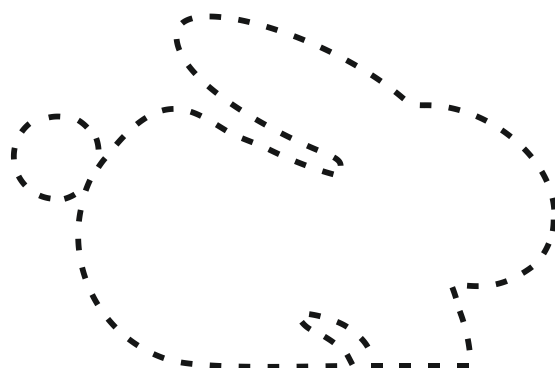

Narysuj linię po śladzie i doprowadź zwierzęta do ich przysmaków.

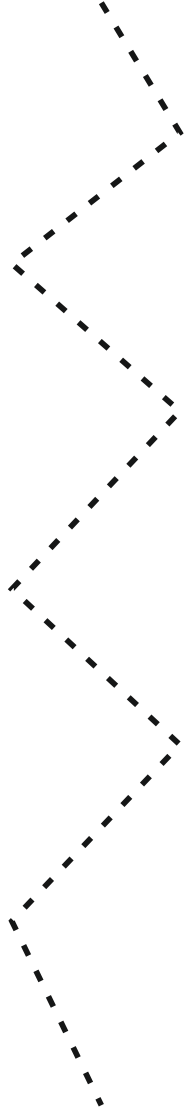
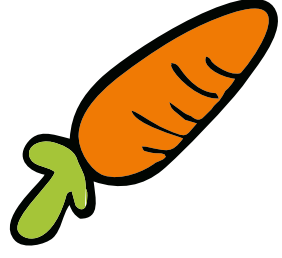
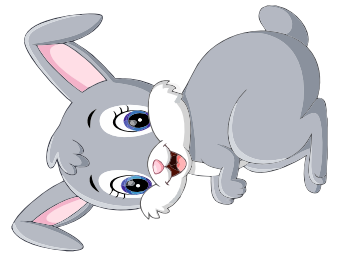
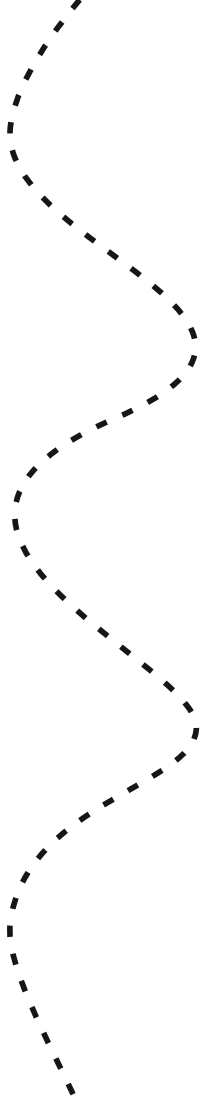
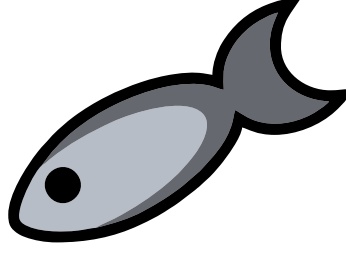
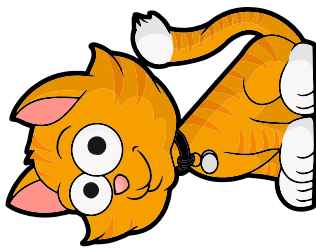
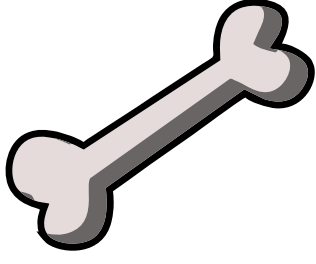

Narysuj kopertę po śladzie, a następnie wyklej ją plasteliną.

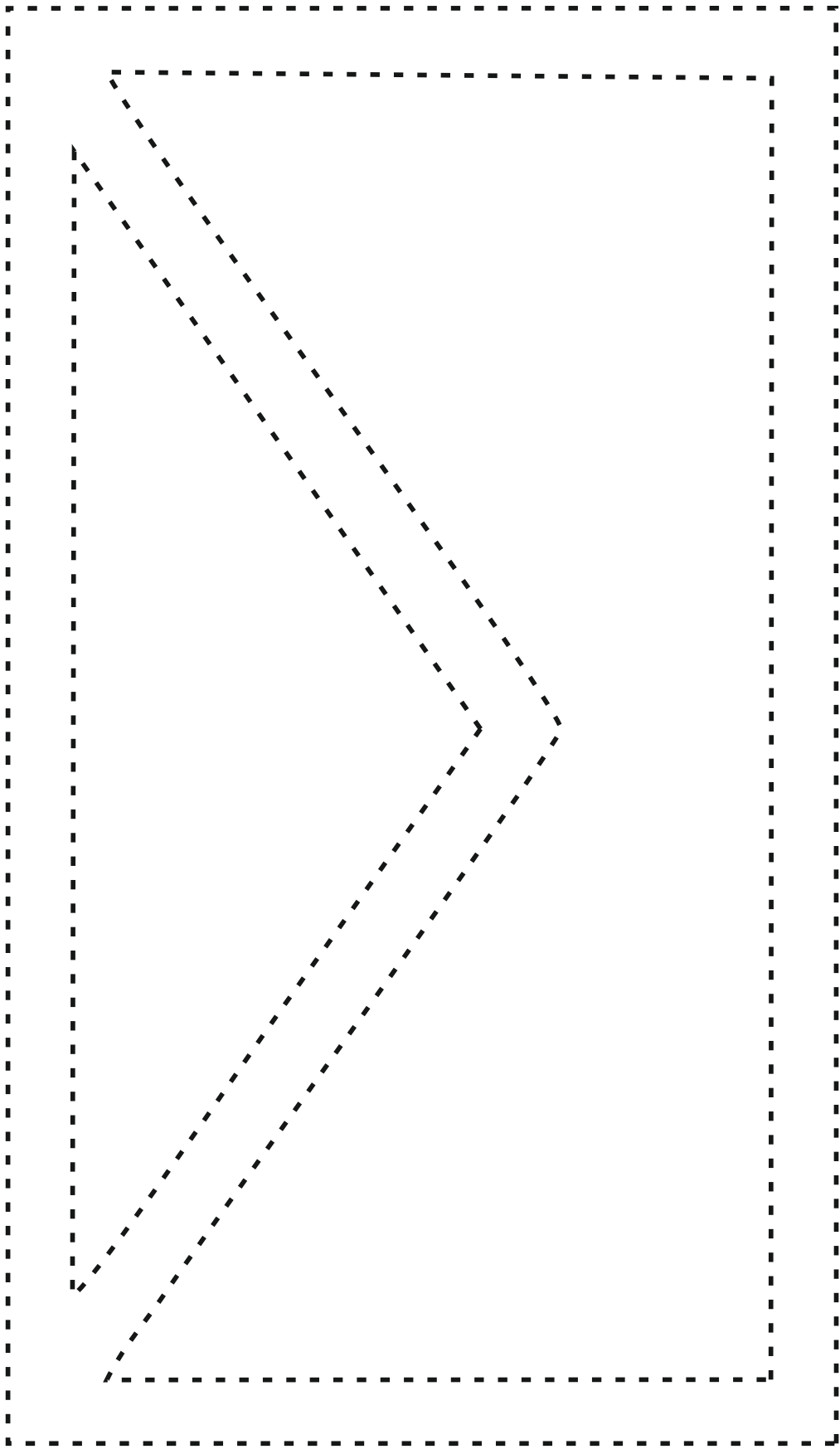

Pomóż listonoszowi włożyć list do odpowiednich toreb.

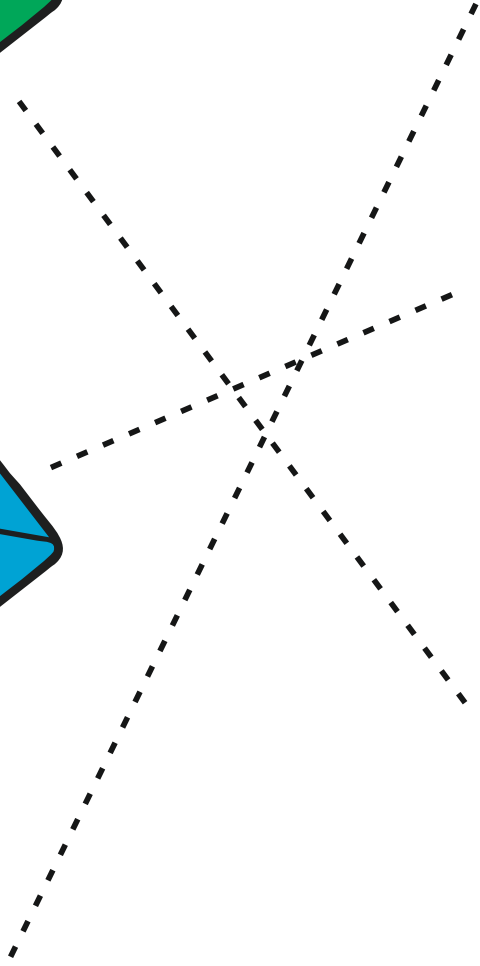
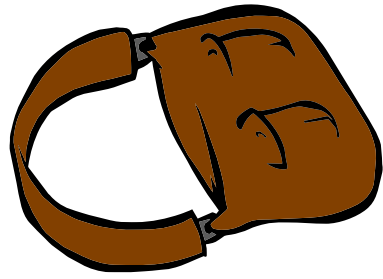
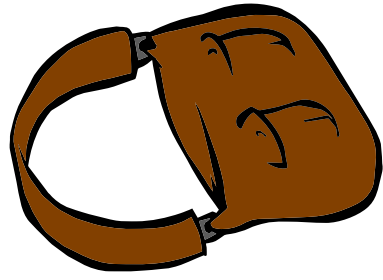
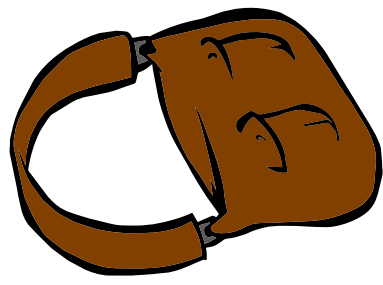
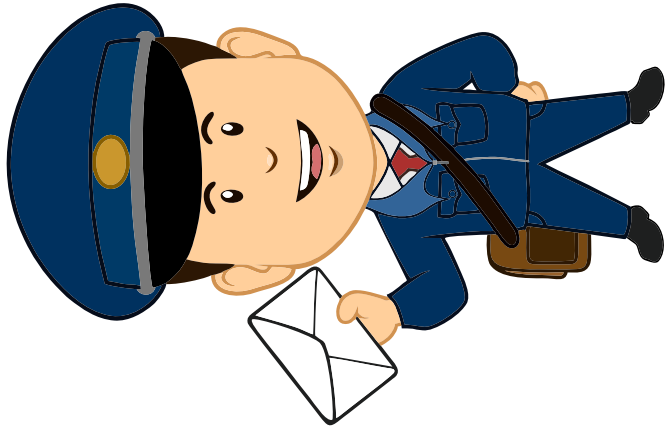
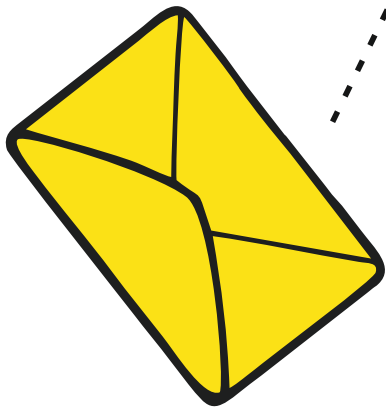
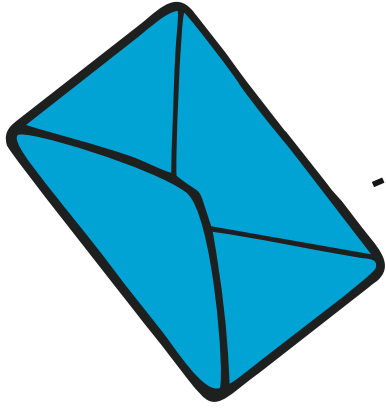
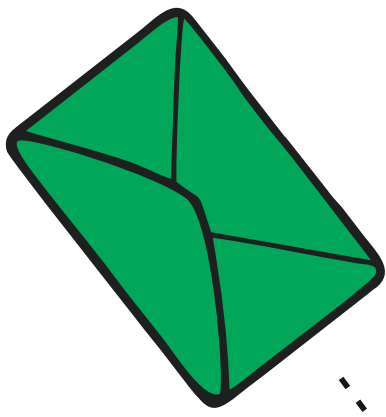

Narysuj głowę kundelka po śladzie i pokoloruj obrazek.

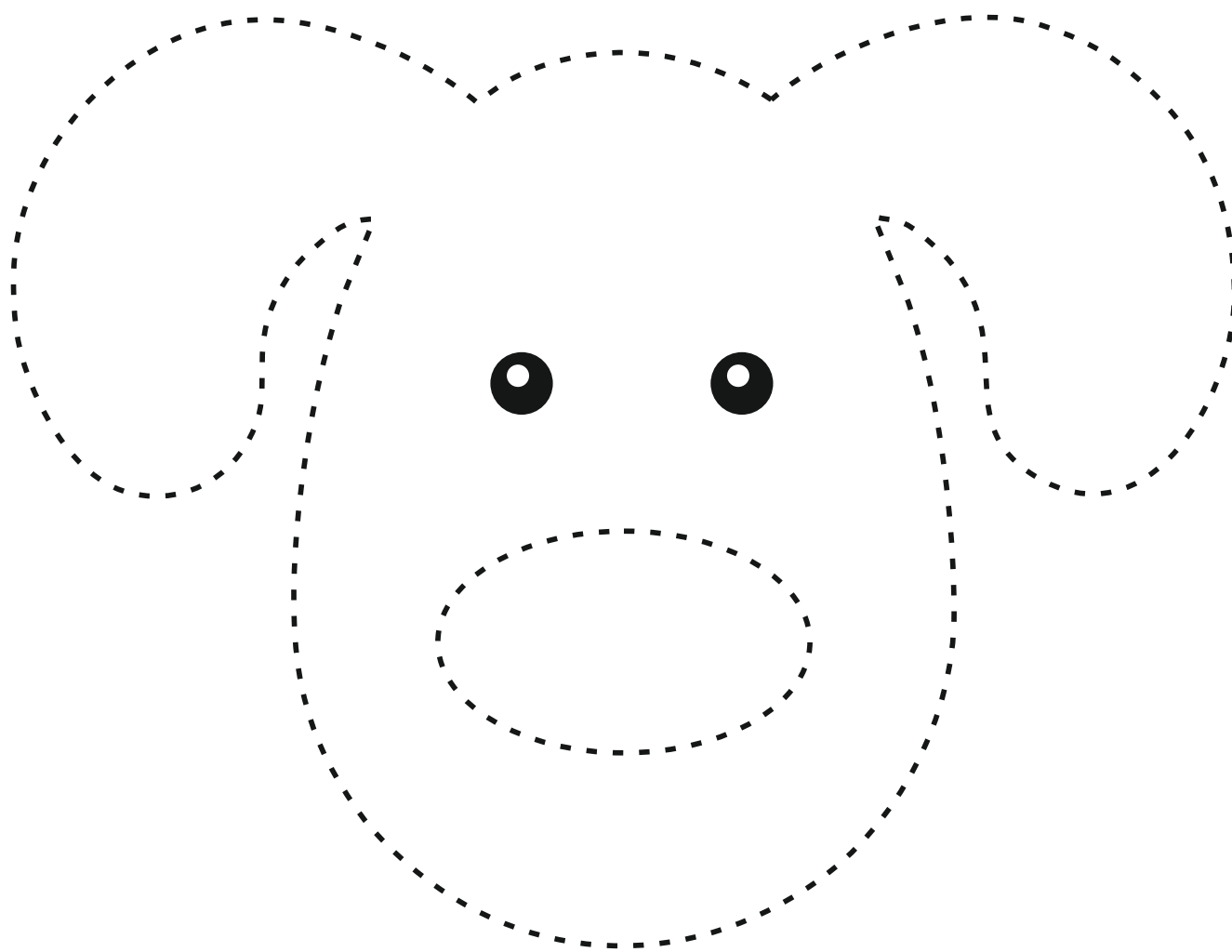

Narysuj pieskowi niezbędne akcesoria.

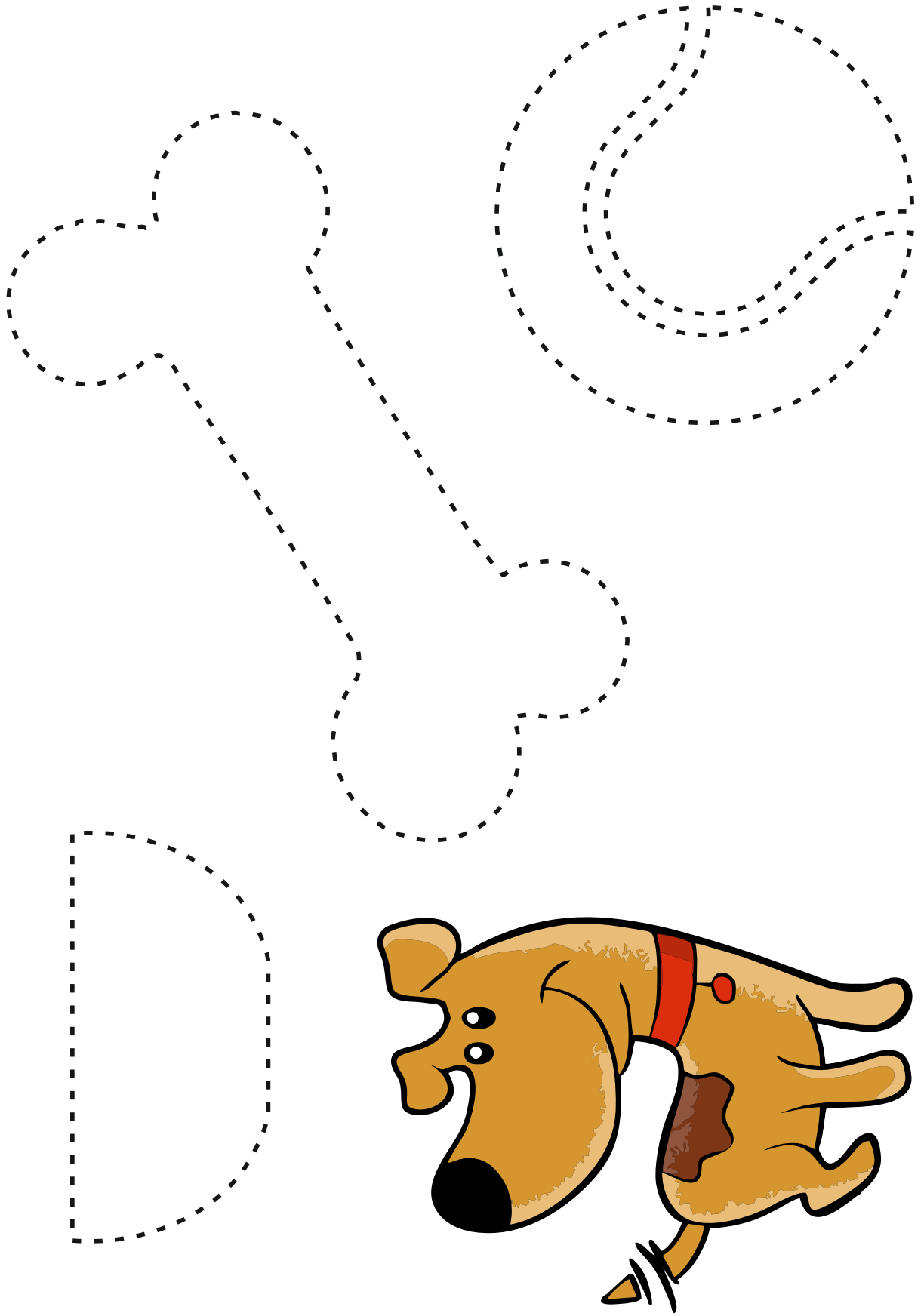

LISTOPAD

Narysuj po śladzie i pokoloruj obrazek.

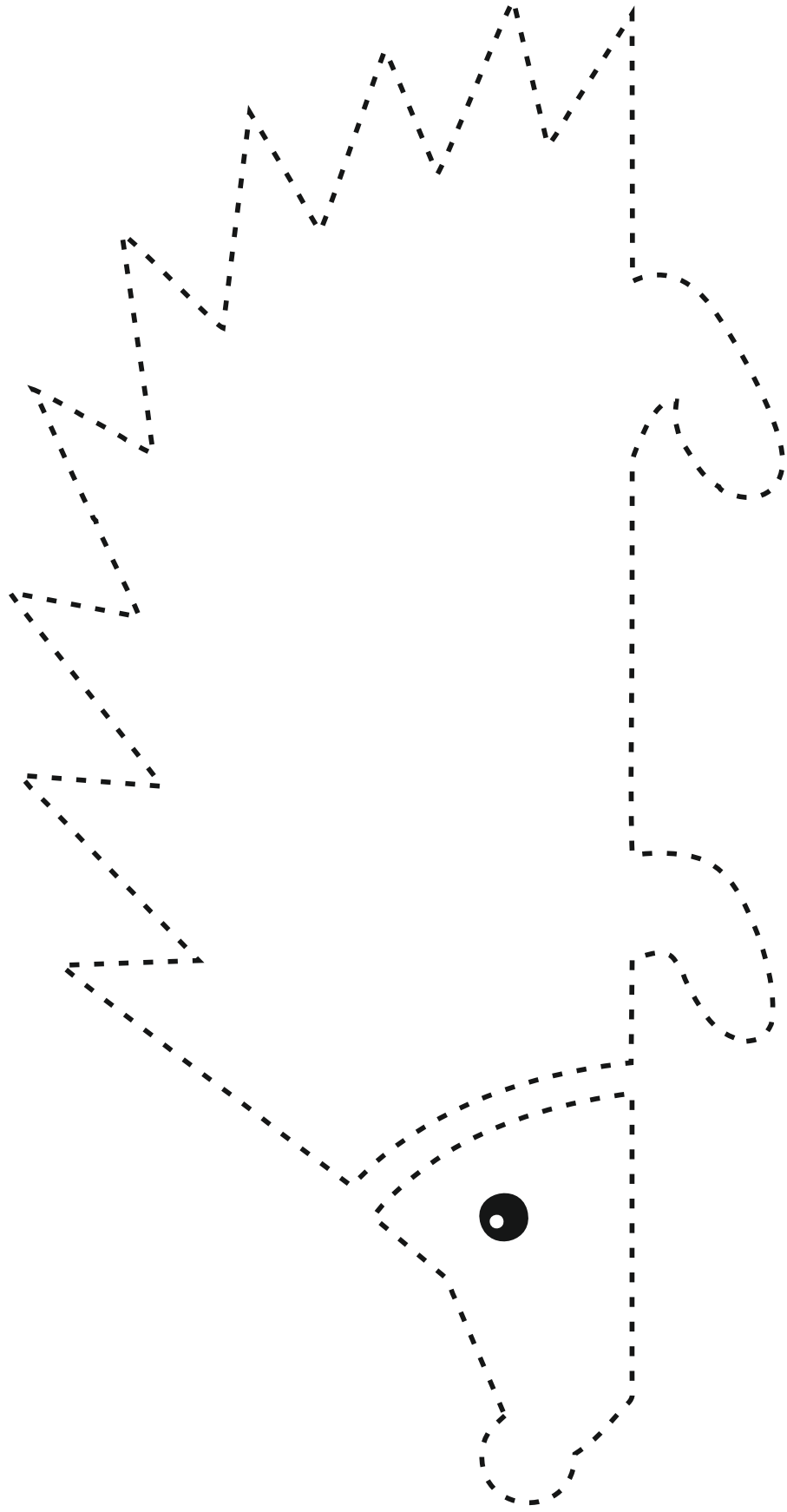

Narysuj kredki po śladzie, a następnie pokoloruj je według koloru poniżej.

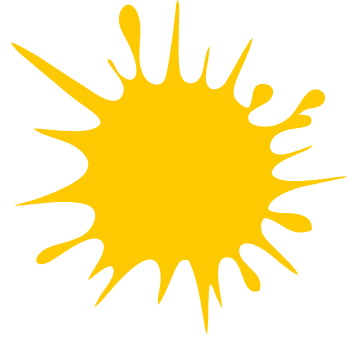
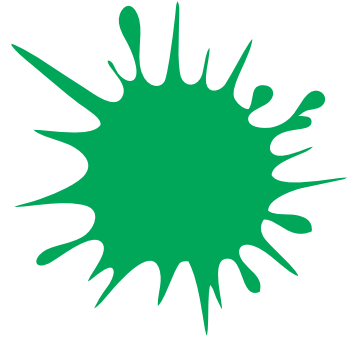
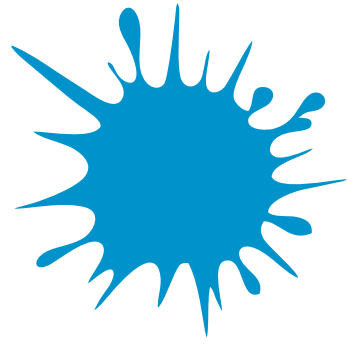
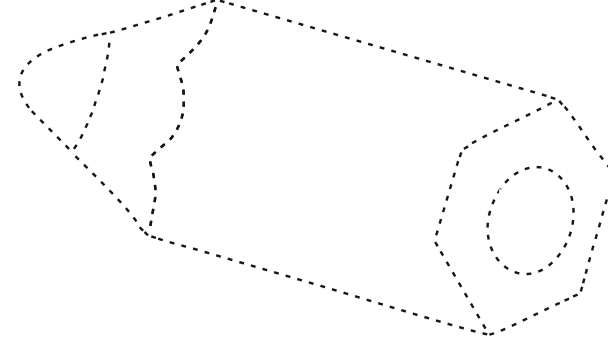
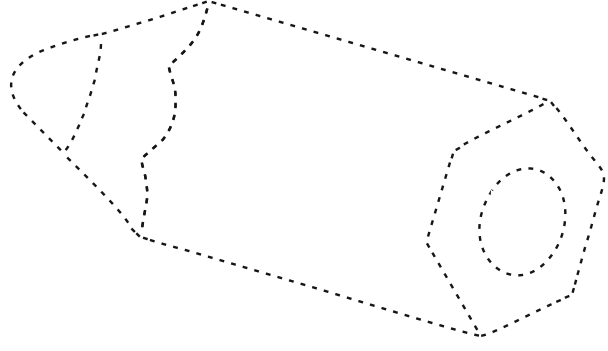
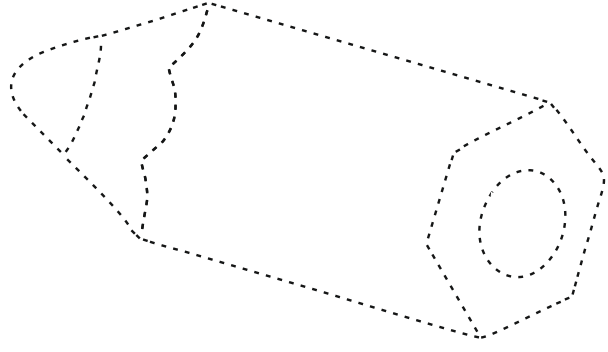
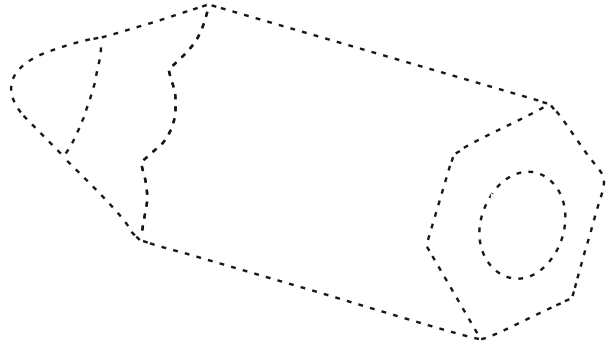

Narysuj pluszowego misia po śladzie, a następnie pomaluj farbami.

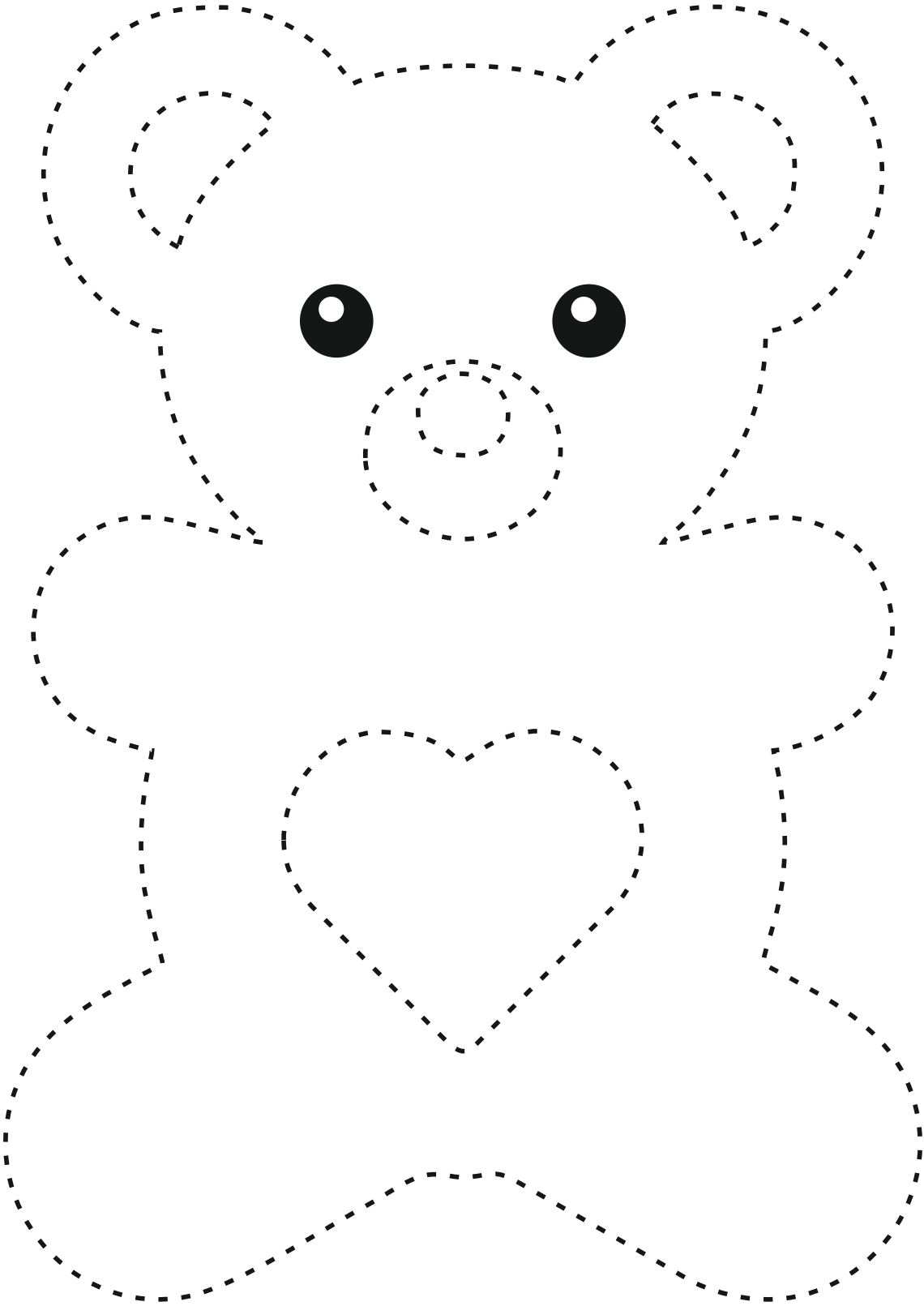

Pomóż pluszowemu misiowi dotrzeć do domku.

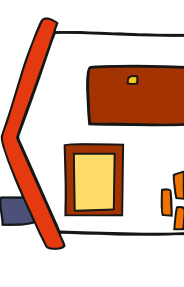
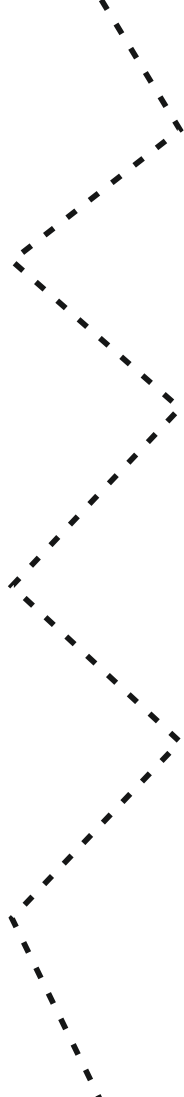
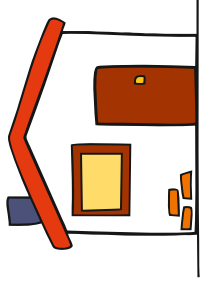
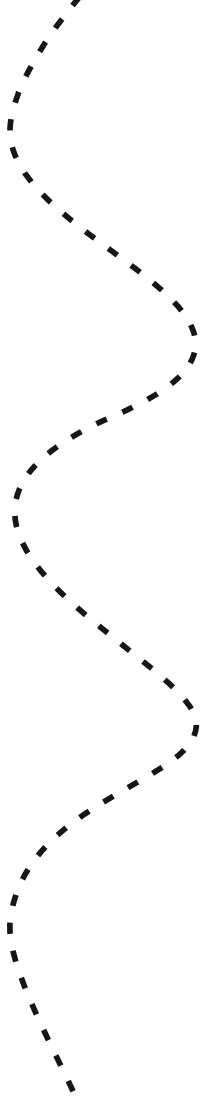
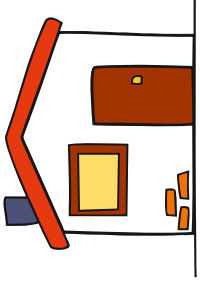

GRUDZIEŃ

Narysuj po śladzie i pokoloruj obrazek.

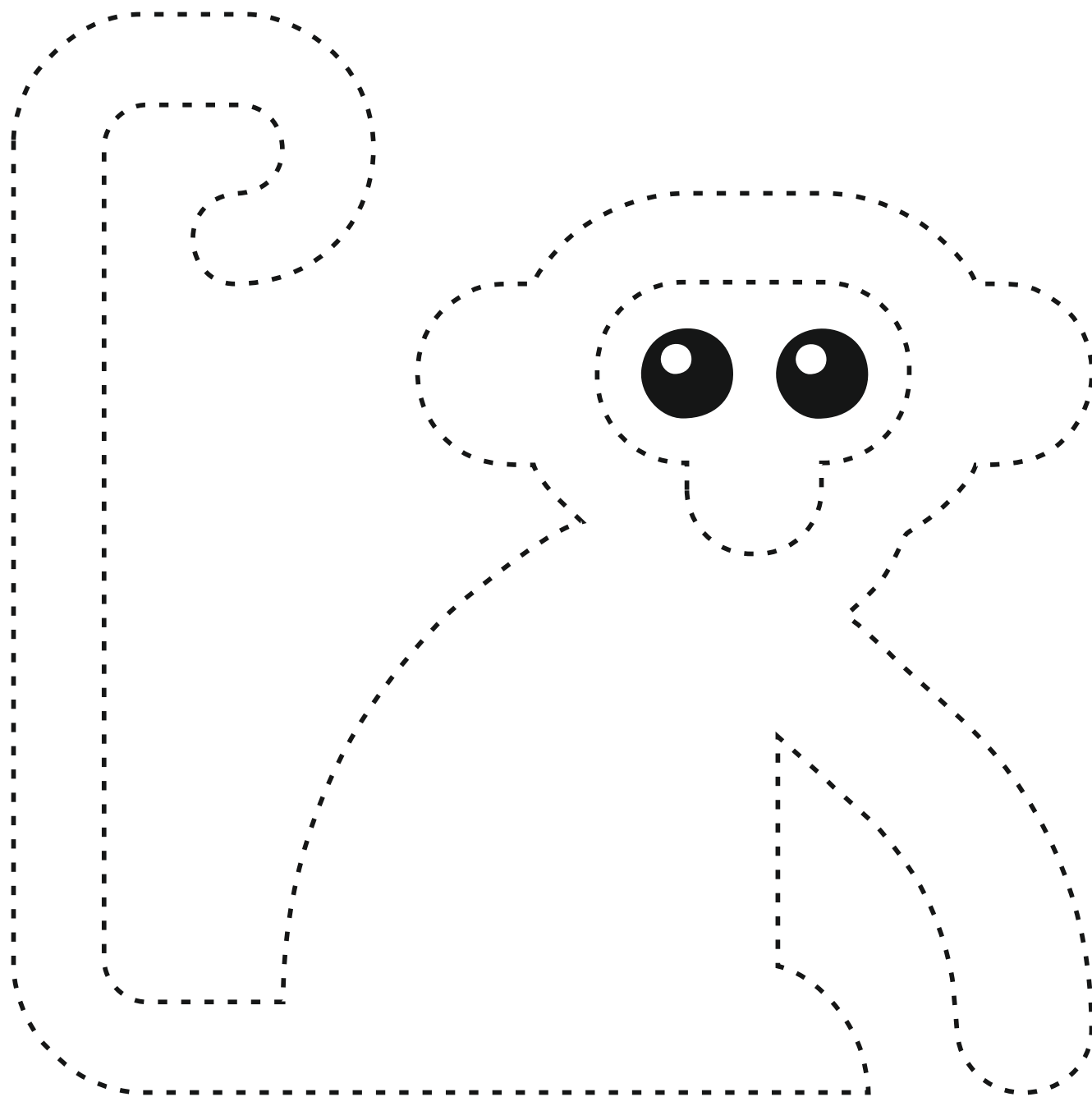

Pomóż małpce dotrzeć do banana.

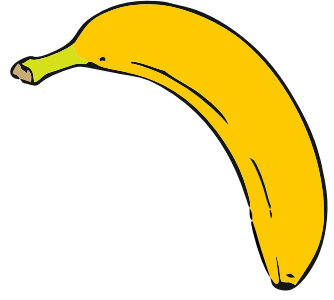
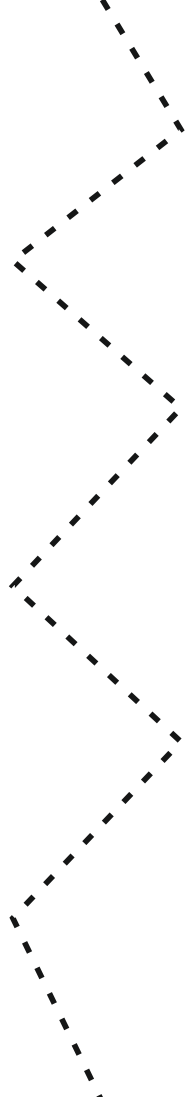
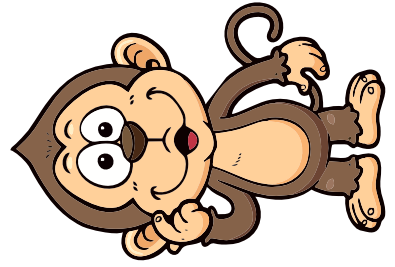
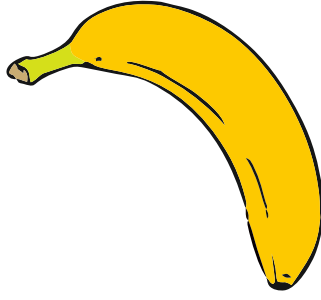
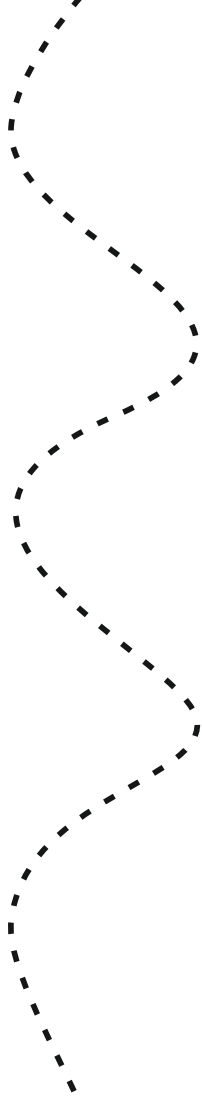
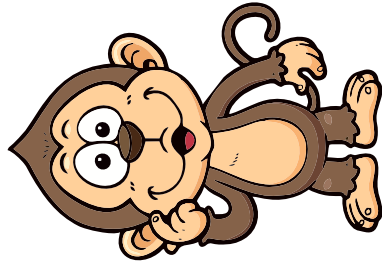
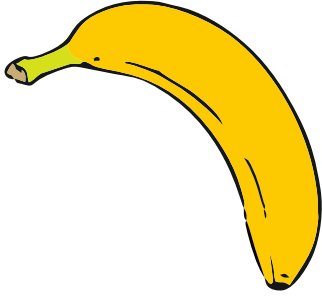
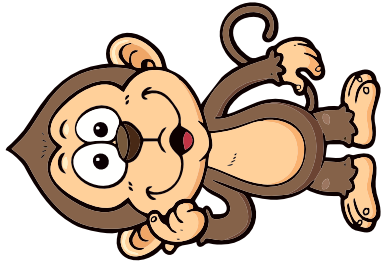

Narysuj po śladzie i pokoloruj obrazek.

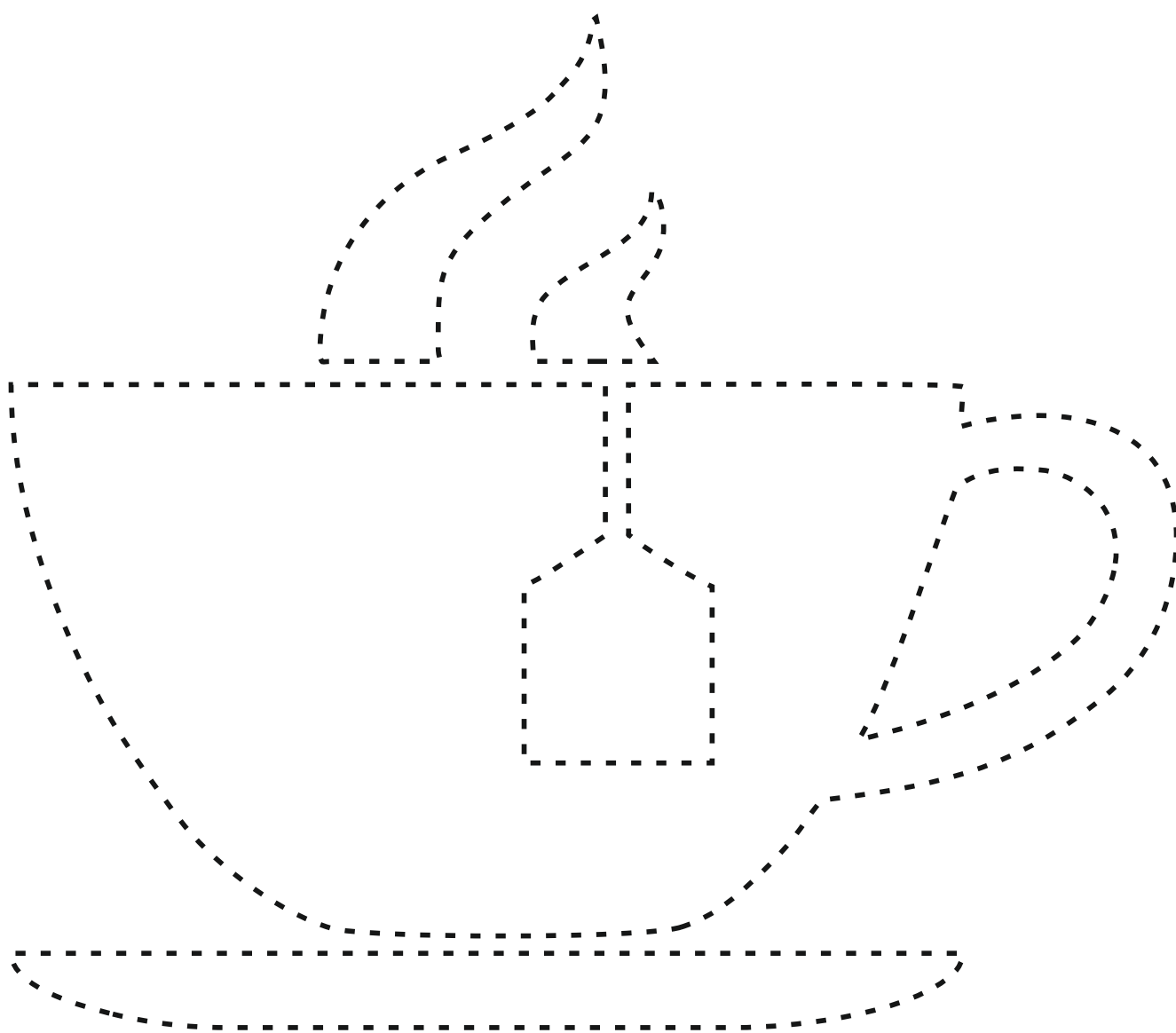

Narysuj po śladzie i odkryj jaki smak może mieć herbata. Nazwij narysowane owoce.

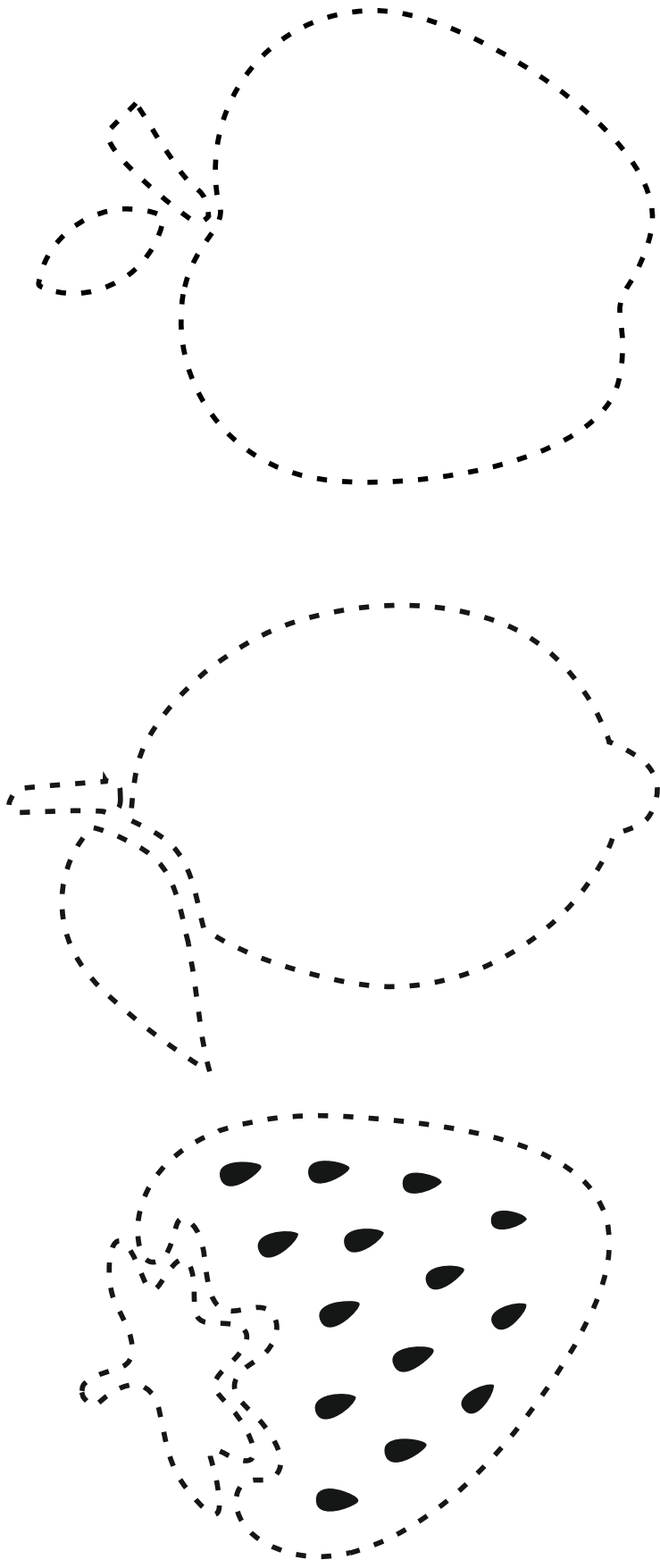

Narysuj po śladzie, a następnie wyklej białą watą.



Narysuj po śladzie, a następnie pokoloruj cały obrazek.

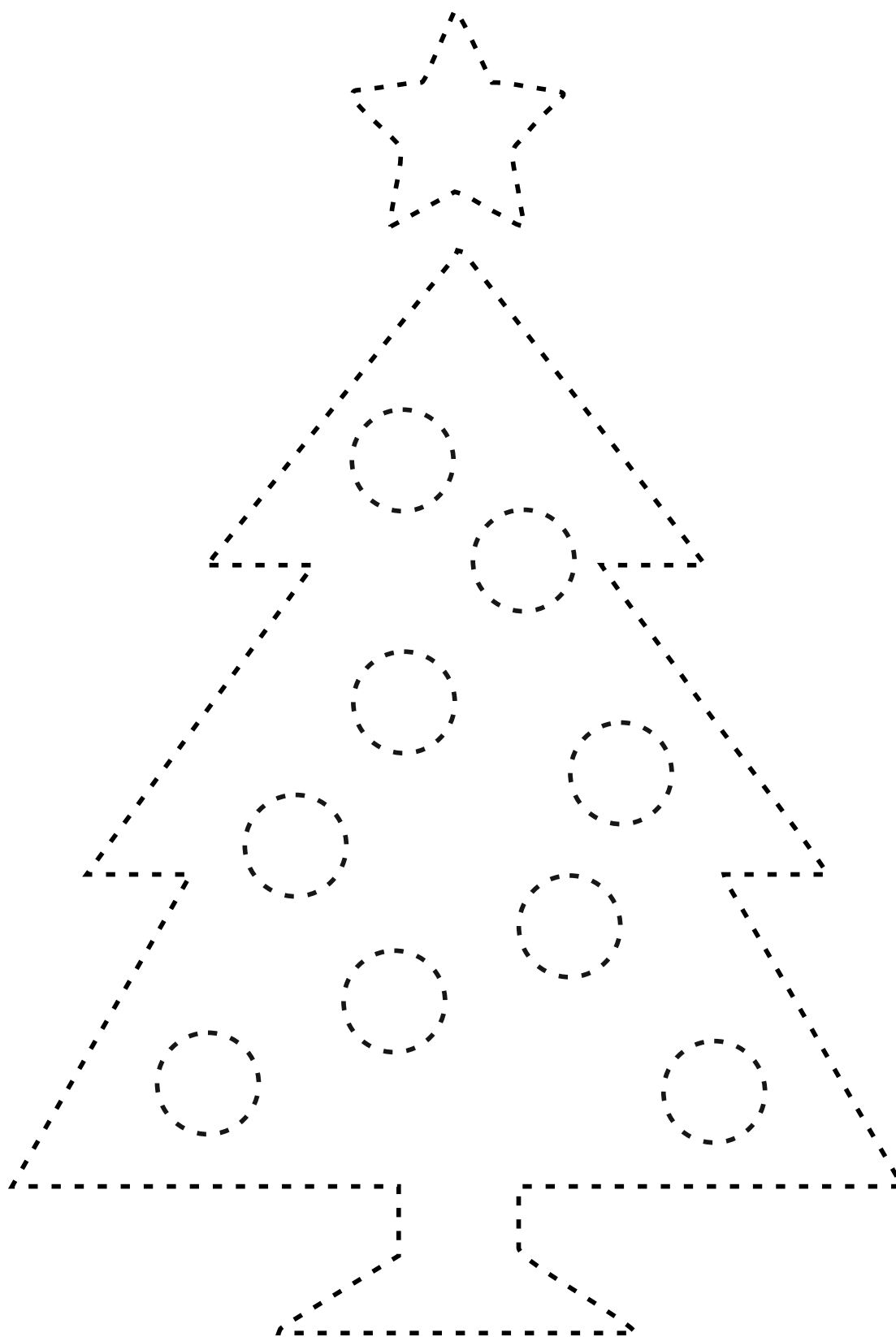

Narysuj po śladzie i pokoloruj obrazek.

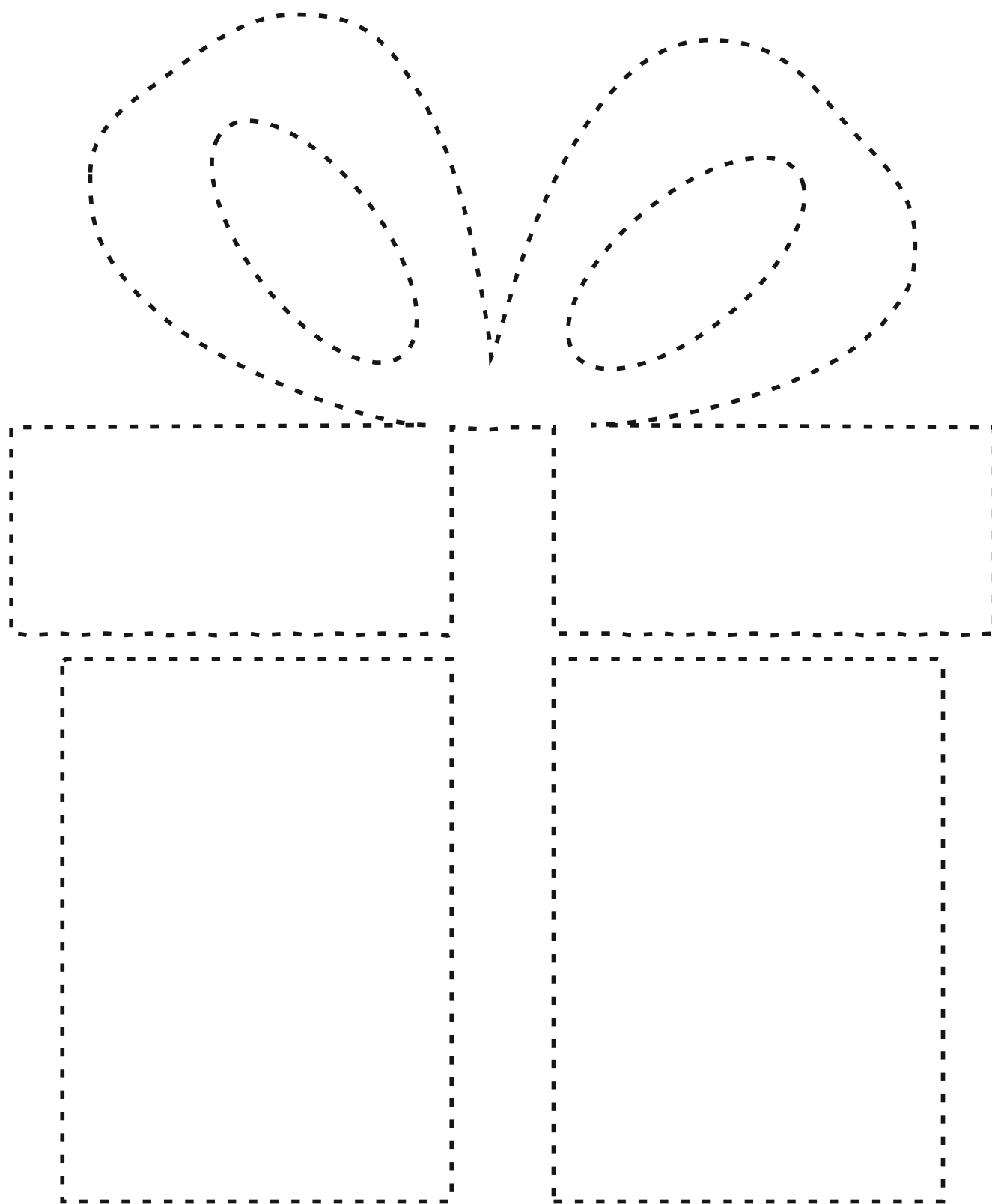

Pomóż Świętemu Mikołajowi wrzucić prezenty do odpowiednich worków.

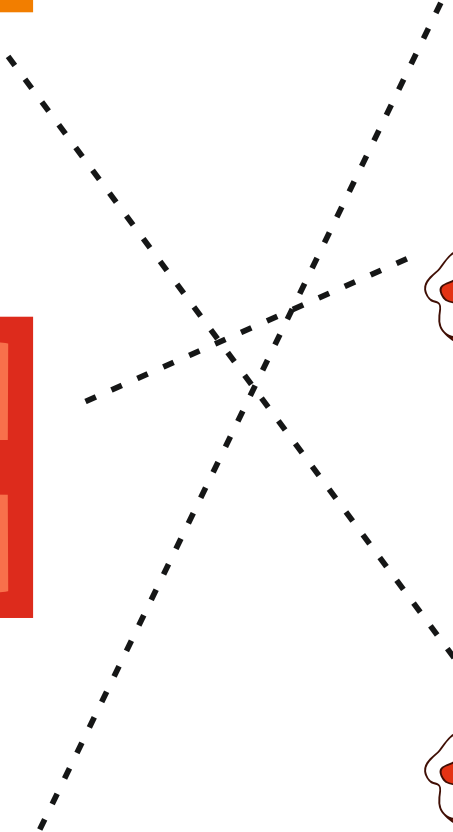
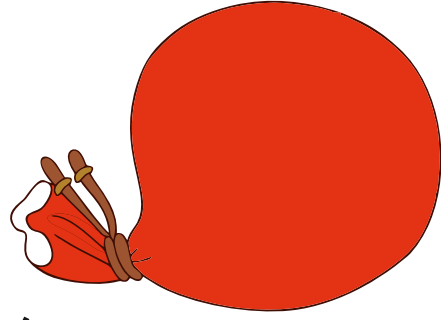
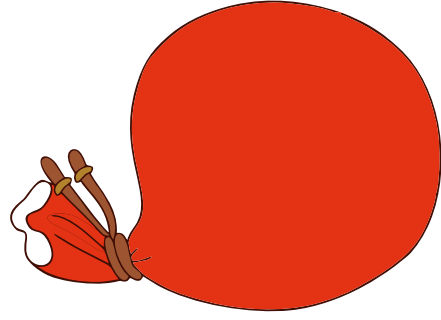
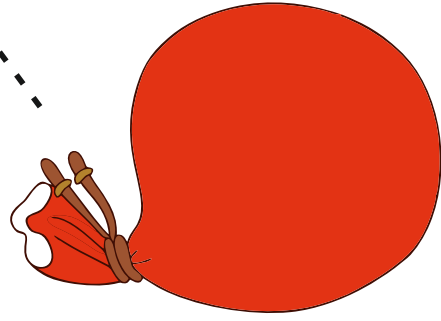
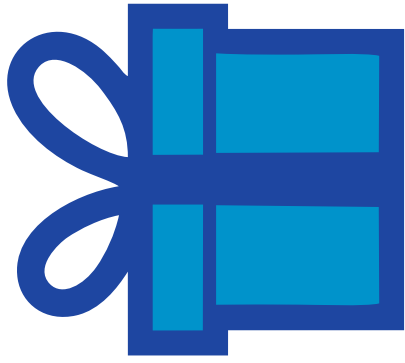

Narysuj fajerwerki po śladzie. Możesz je ozdobić brokatem.

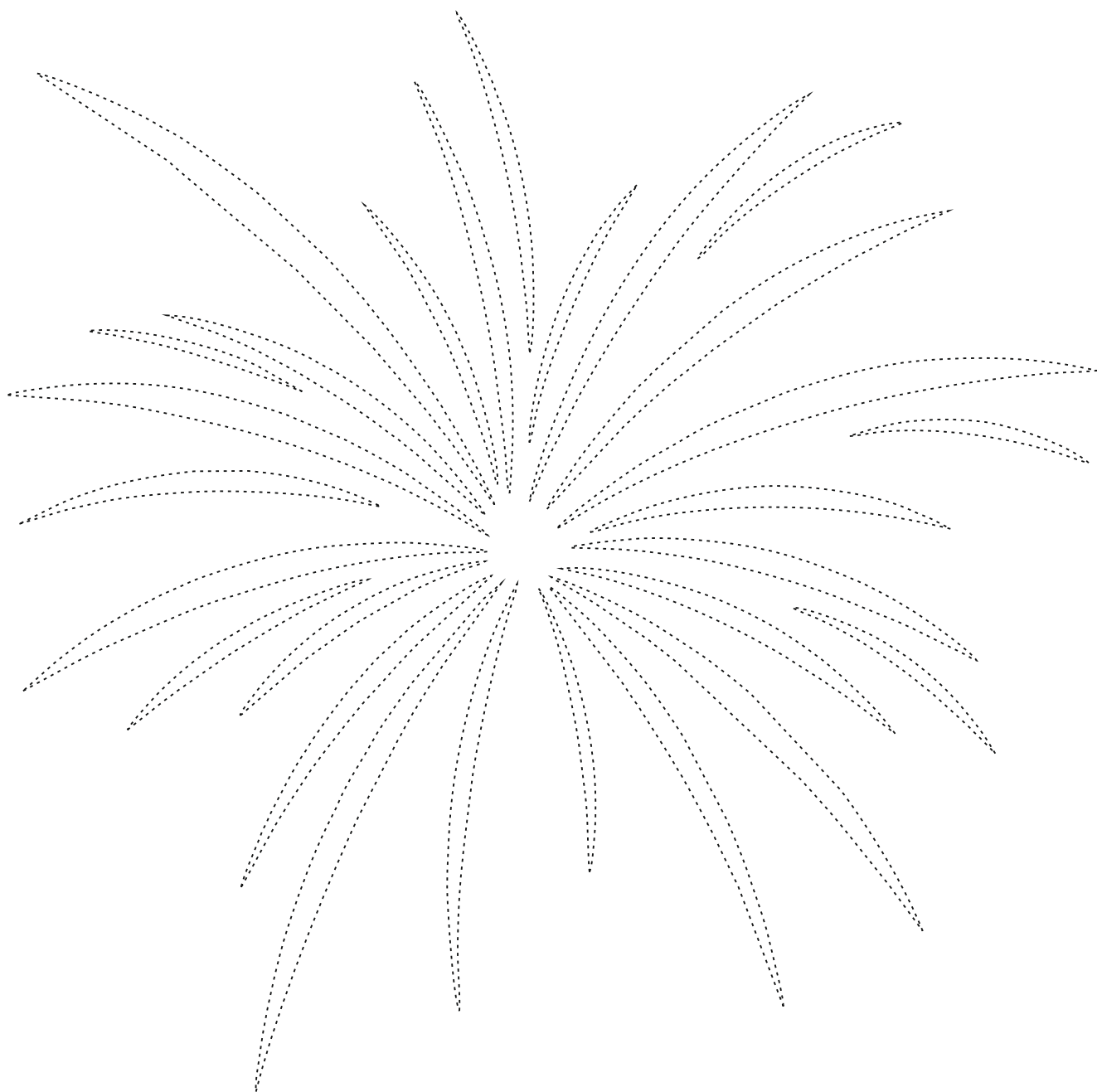

STYCZEŃ

Narysuj po śladzie, a następnie pokoloruj cały obrazek.

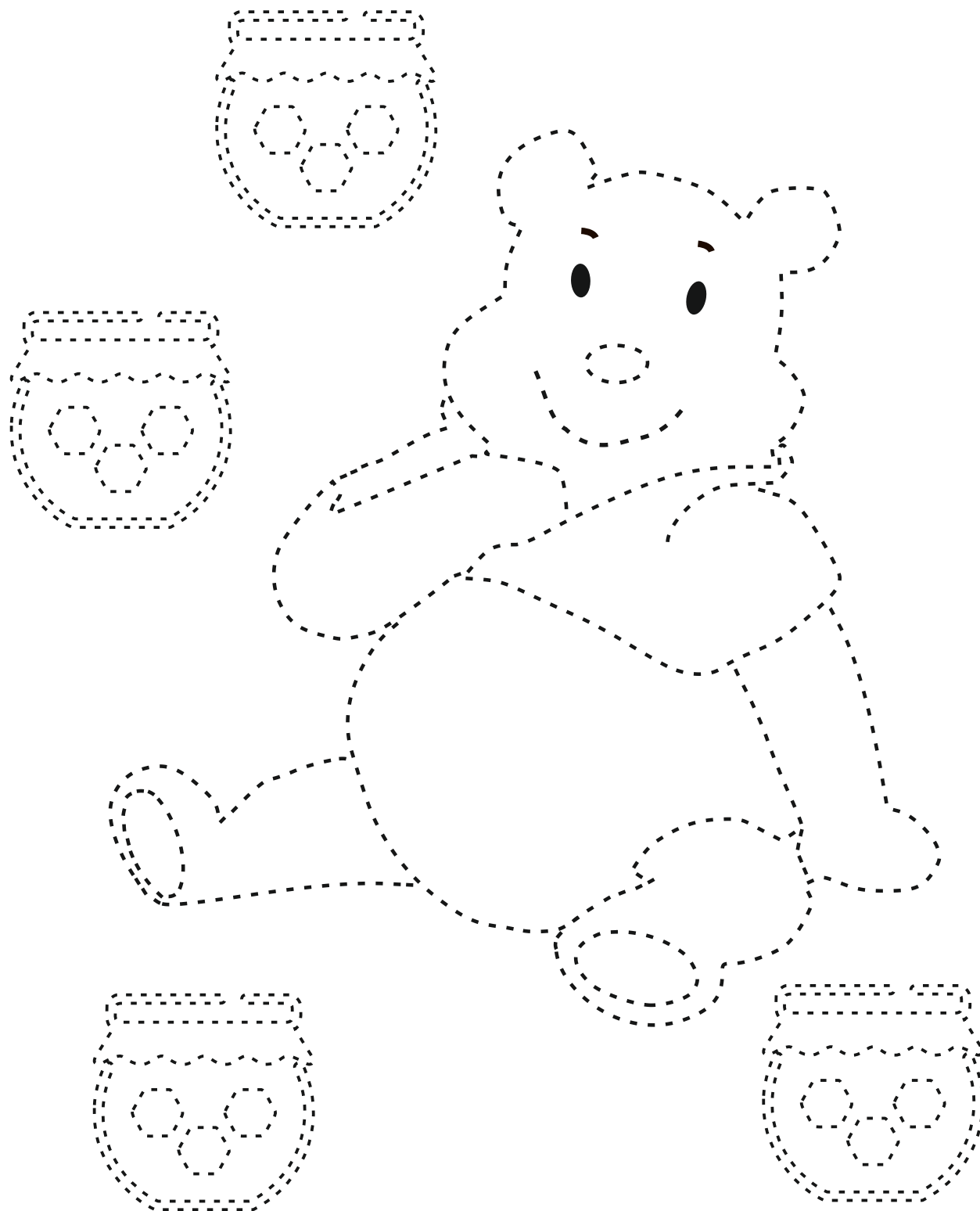

Narysuj płatki śniegu po śladzie, a następnie wyklej białą watą.

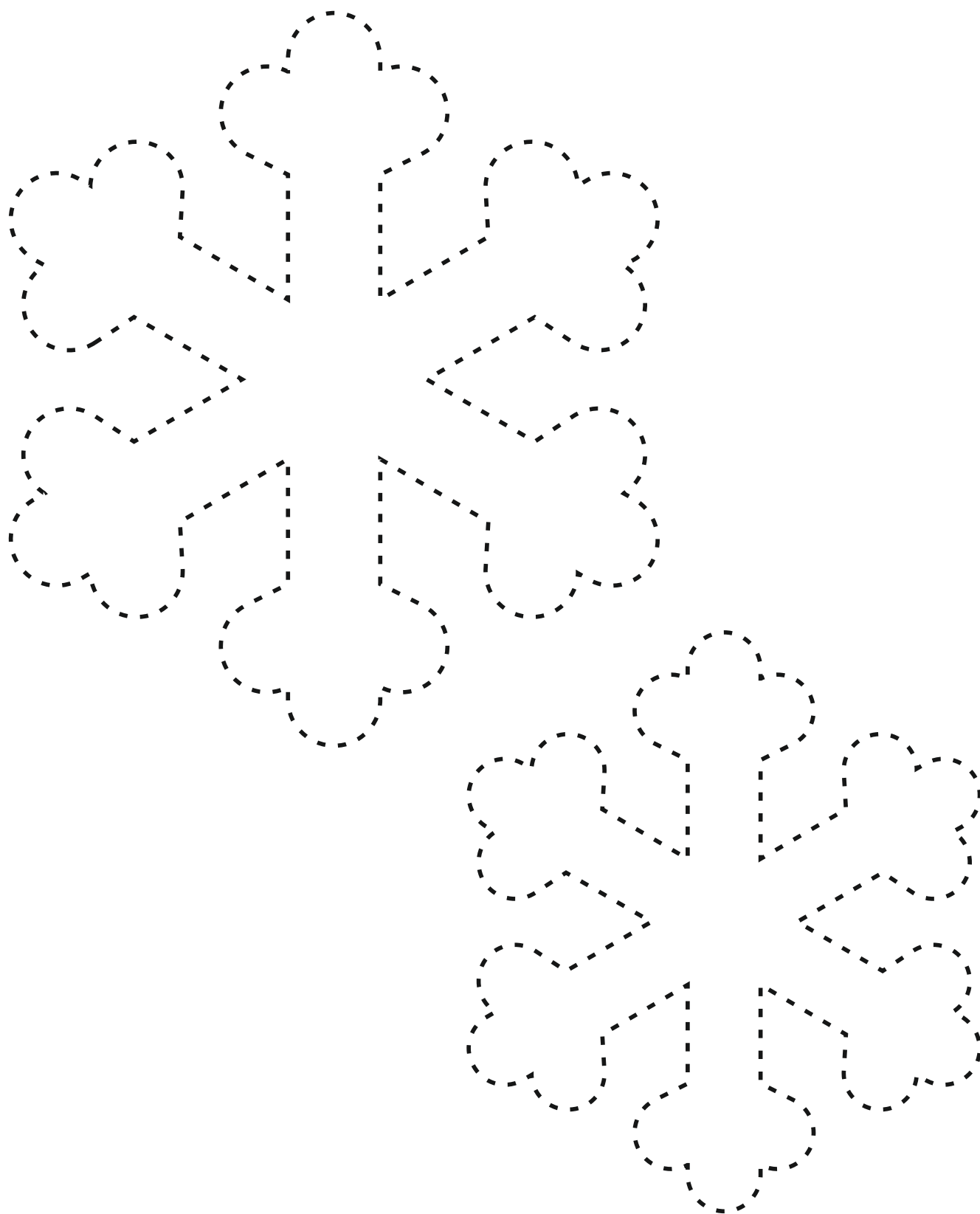

Narysuj po śladzie tor spadania śnieżynek.



Narysuj zebre po śladzie.

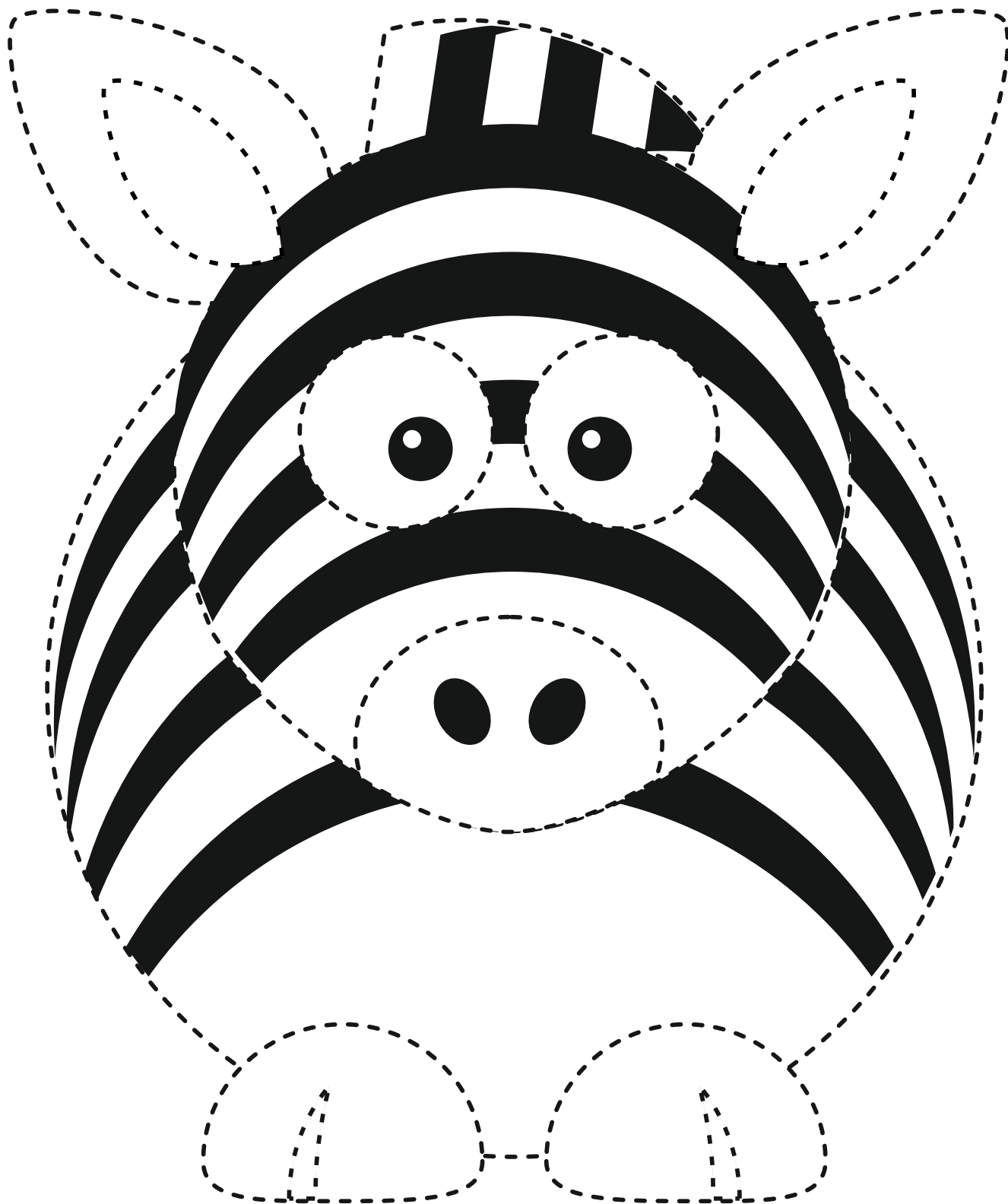

Sprawdź, jakie prezenty otrzymają babcia z dziadkiem.

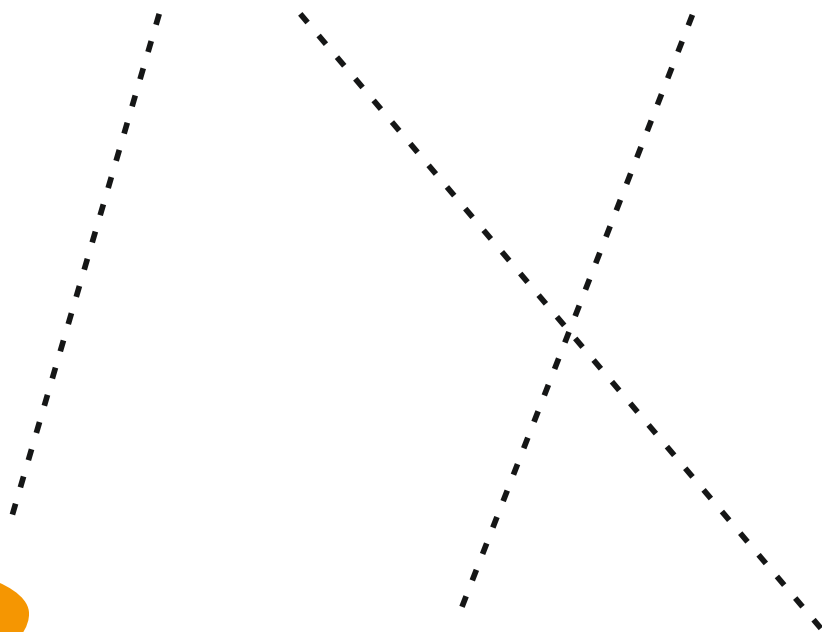
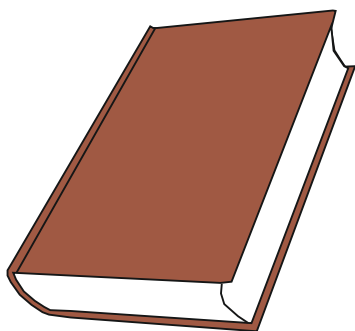
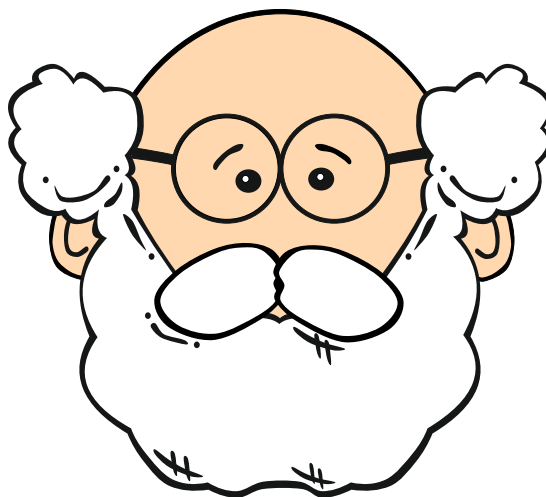
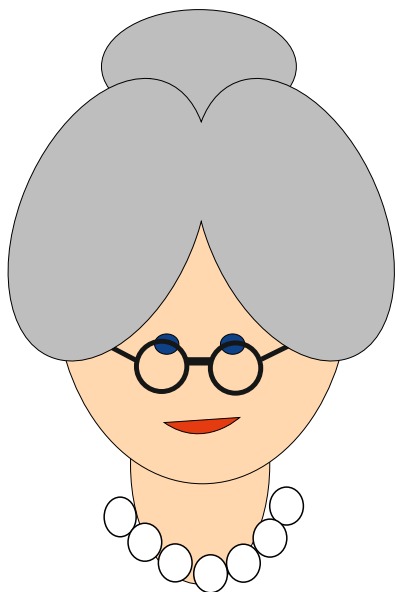

LUTY

Narysuj pizzę po śladzie i pokoloruj obrazek.

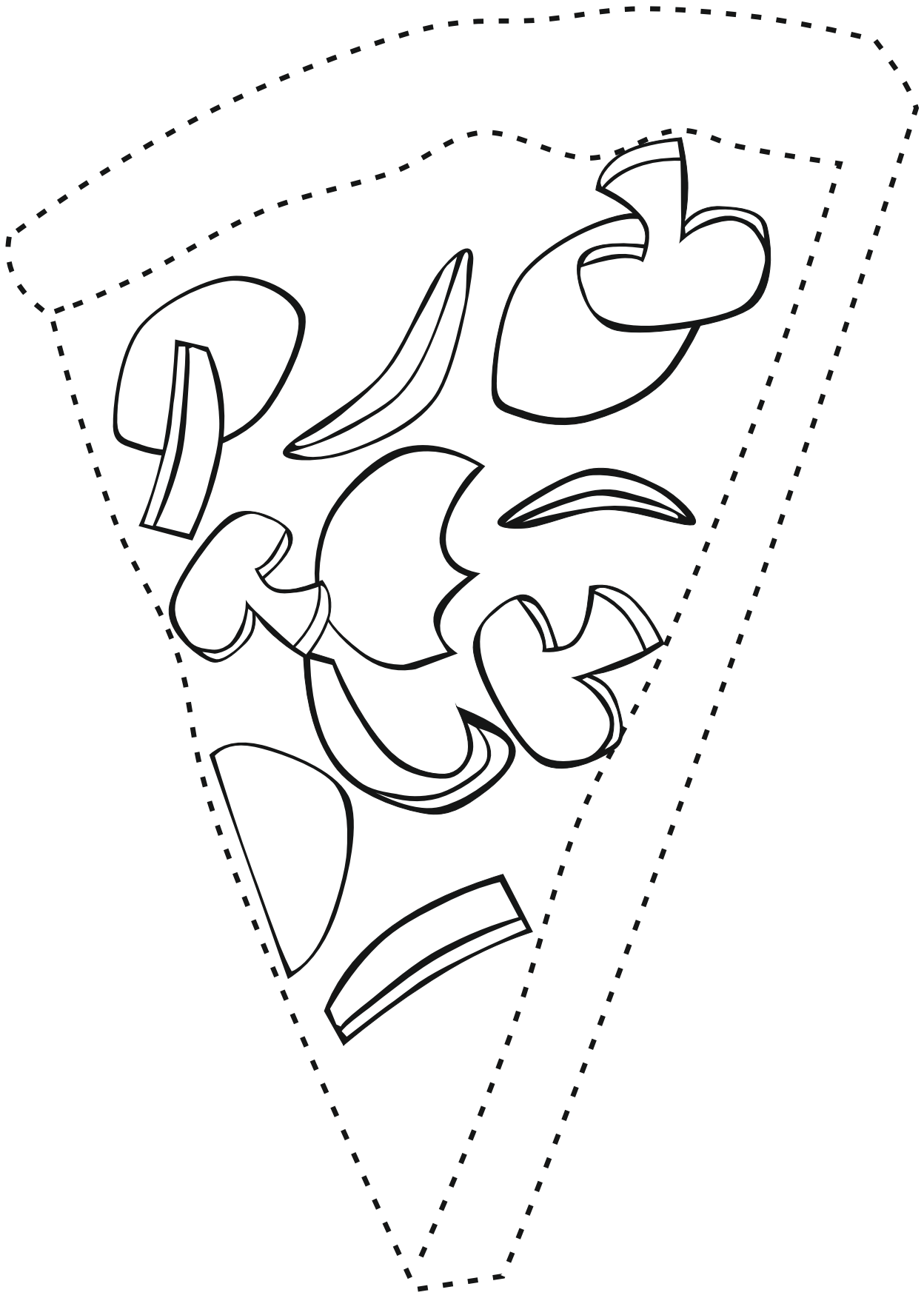

Narysuj po śladzie i dowiedz się jakich składników, używa się do pizzy.

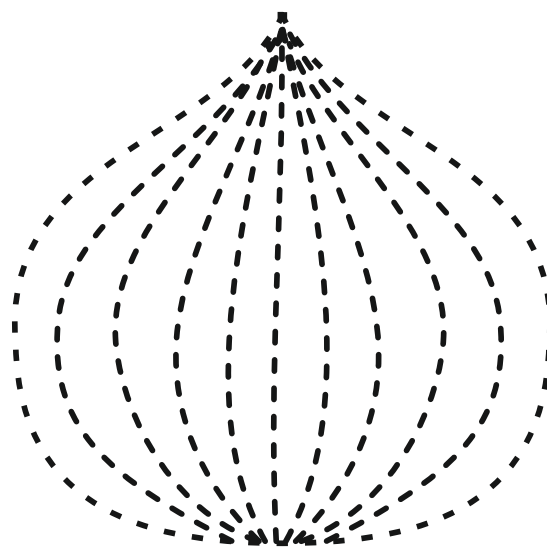
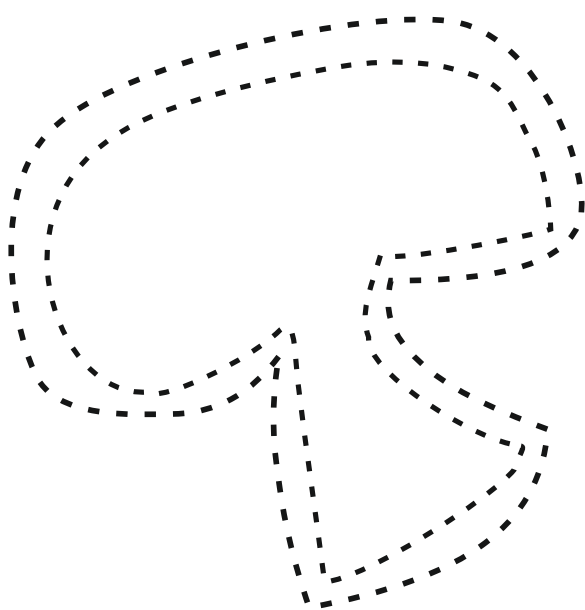
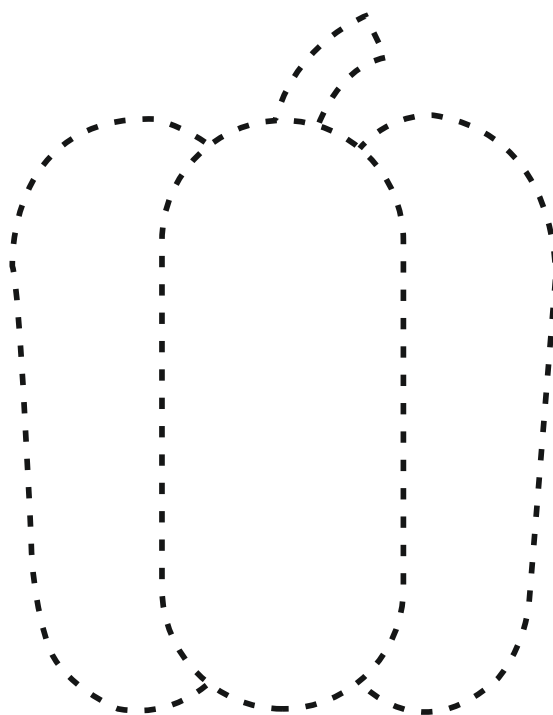
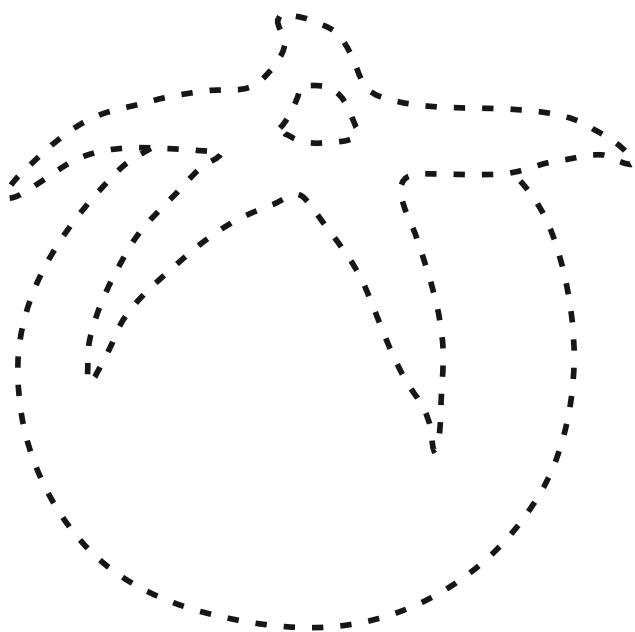

Narysuj po śladzie i pokoloruj obrazek.

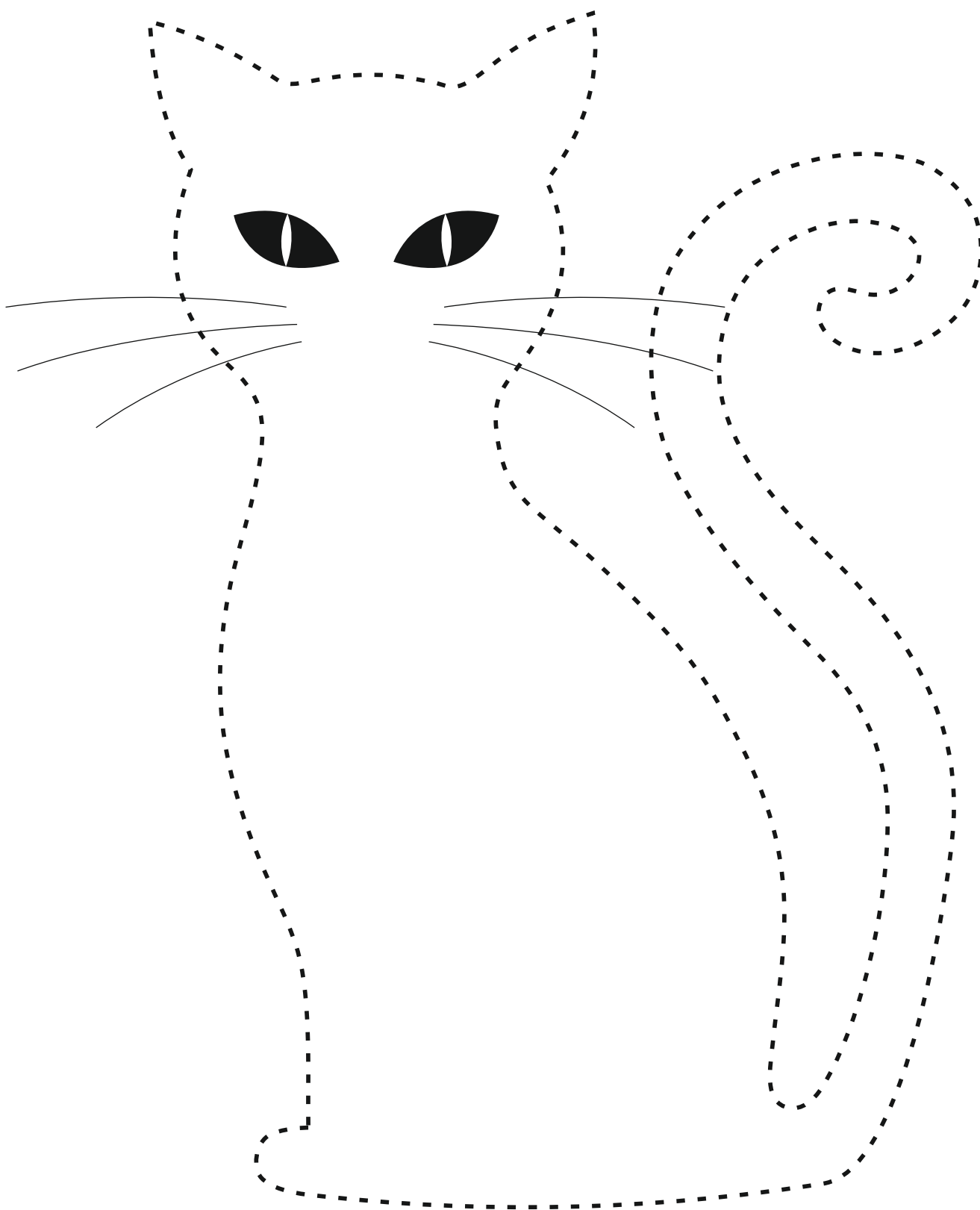

Narysuj linie po śladzie i doprowadź kota do ryby.

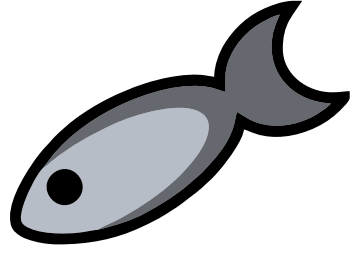
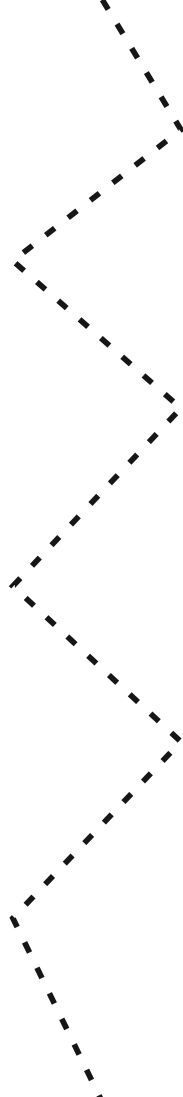
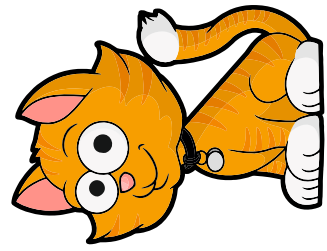
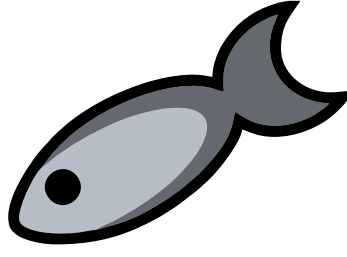
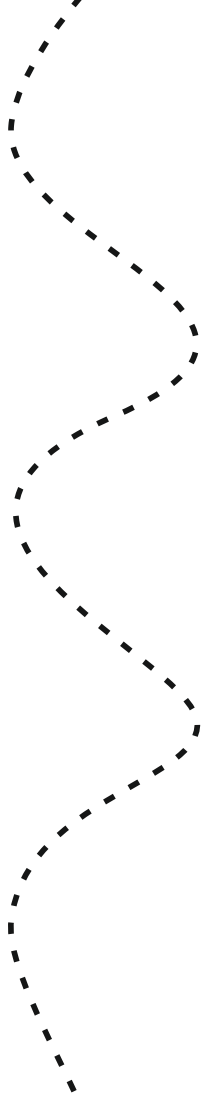
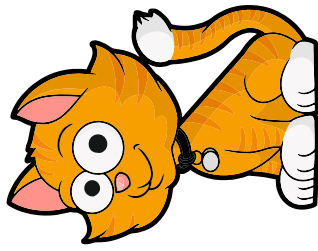
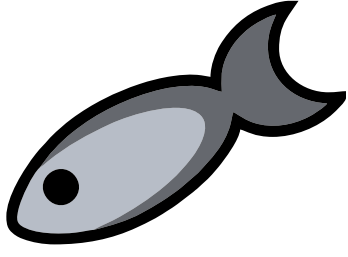
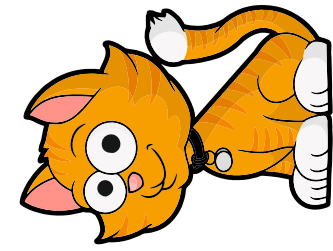

Narysuj dinozaura po śladzie, a następnie wyklej plasteliną.

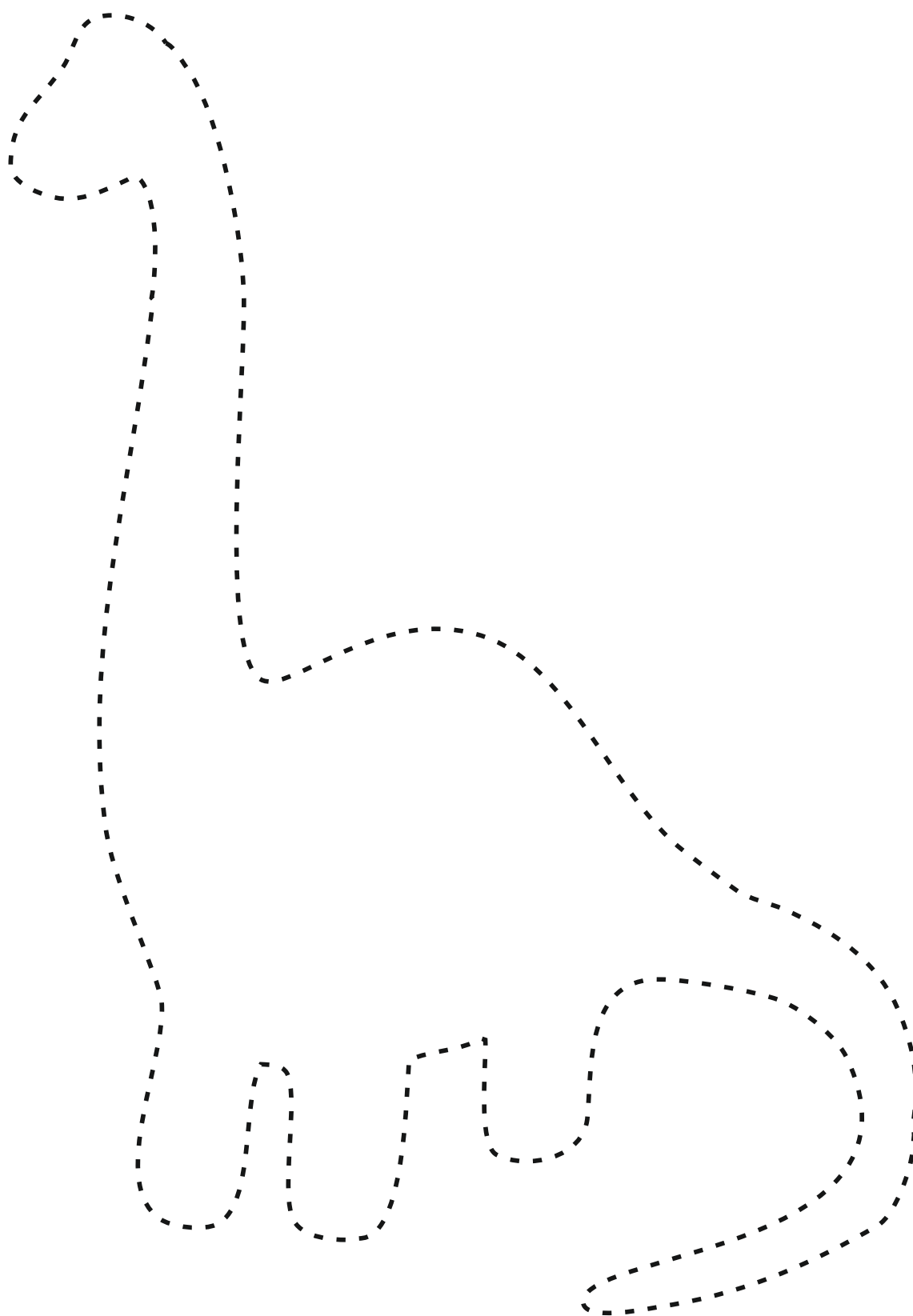

Pomóż Dinusiom odnaleźć swoich braci. Pokoloruj kredką odpowiadającą danemu dinozaurowi.

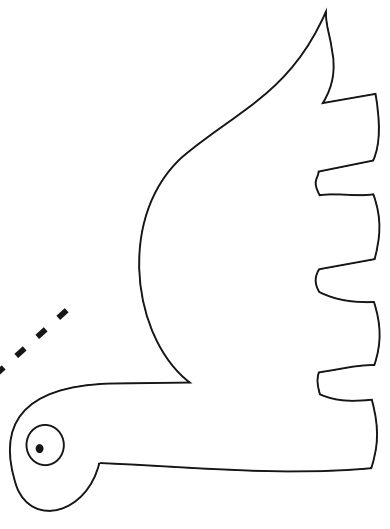
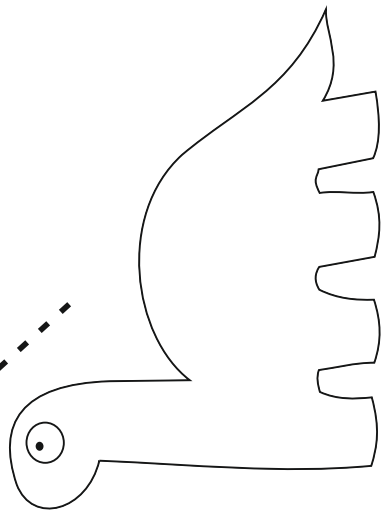
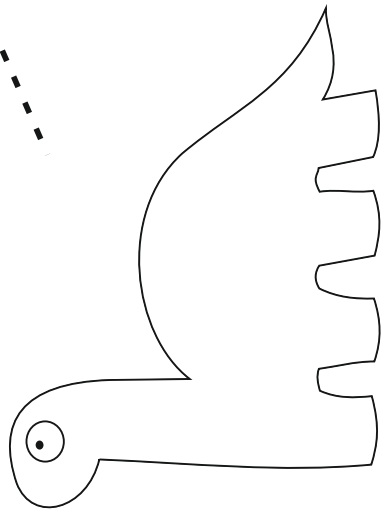
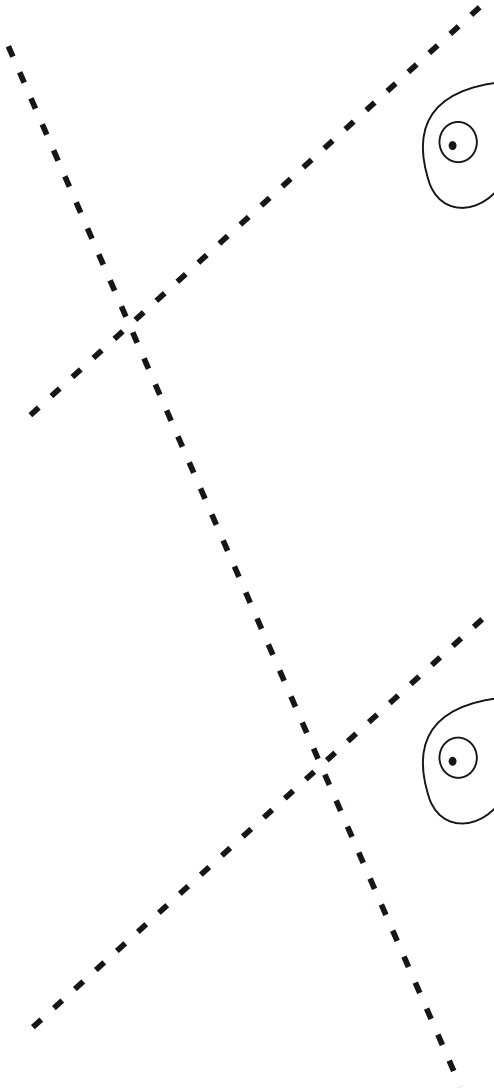
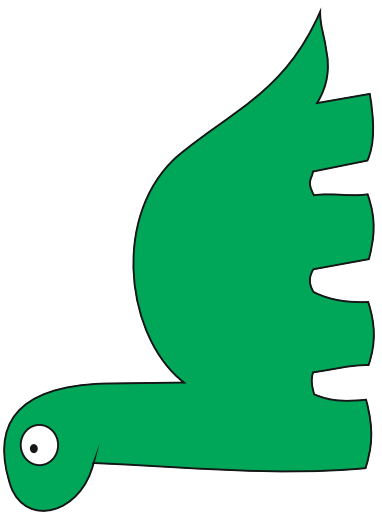
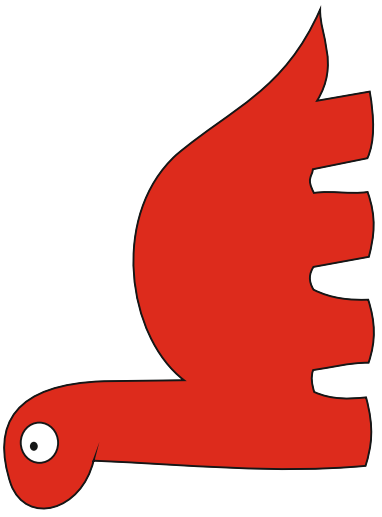
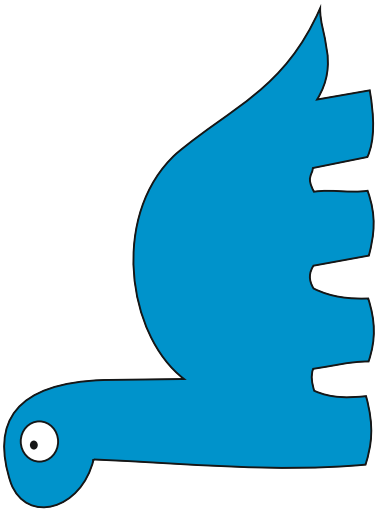

Narysuj niedźwiedzia polarnego po śladzie, a następnie wyklej białą watą.

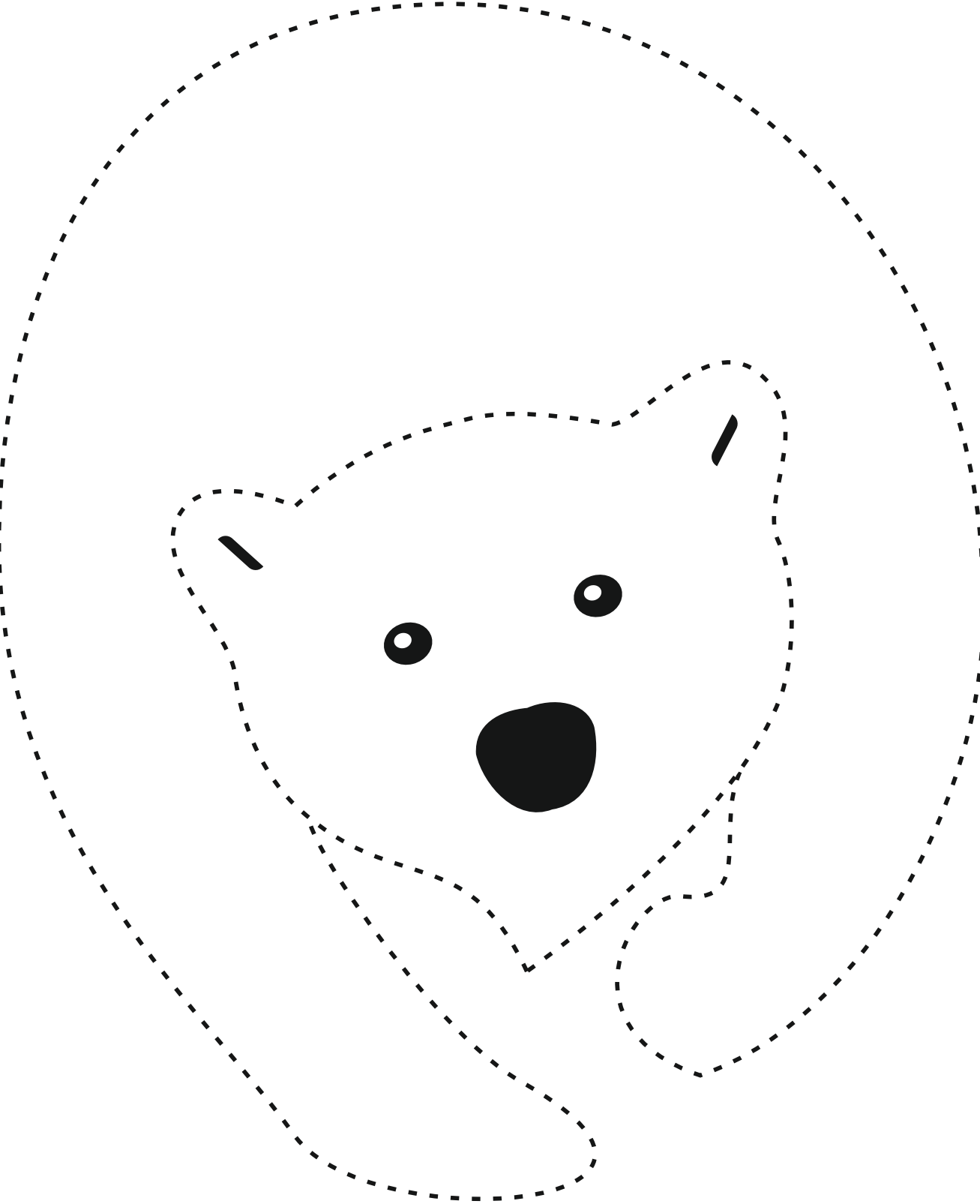

Stwórz walentynkę. Narysuj serca po śladzie i wyklej czerwoną plasteliną.

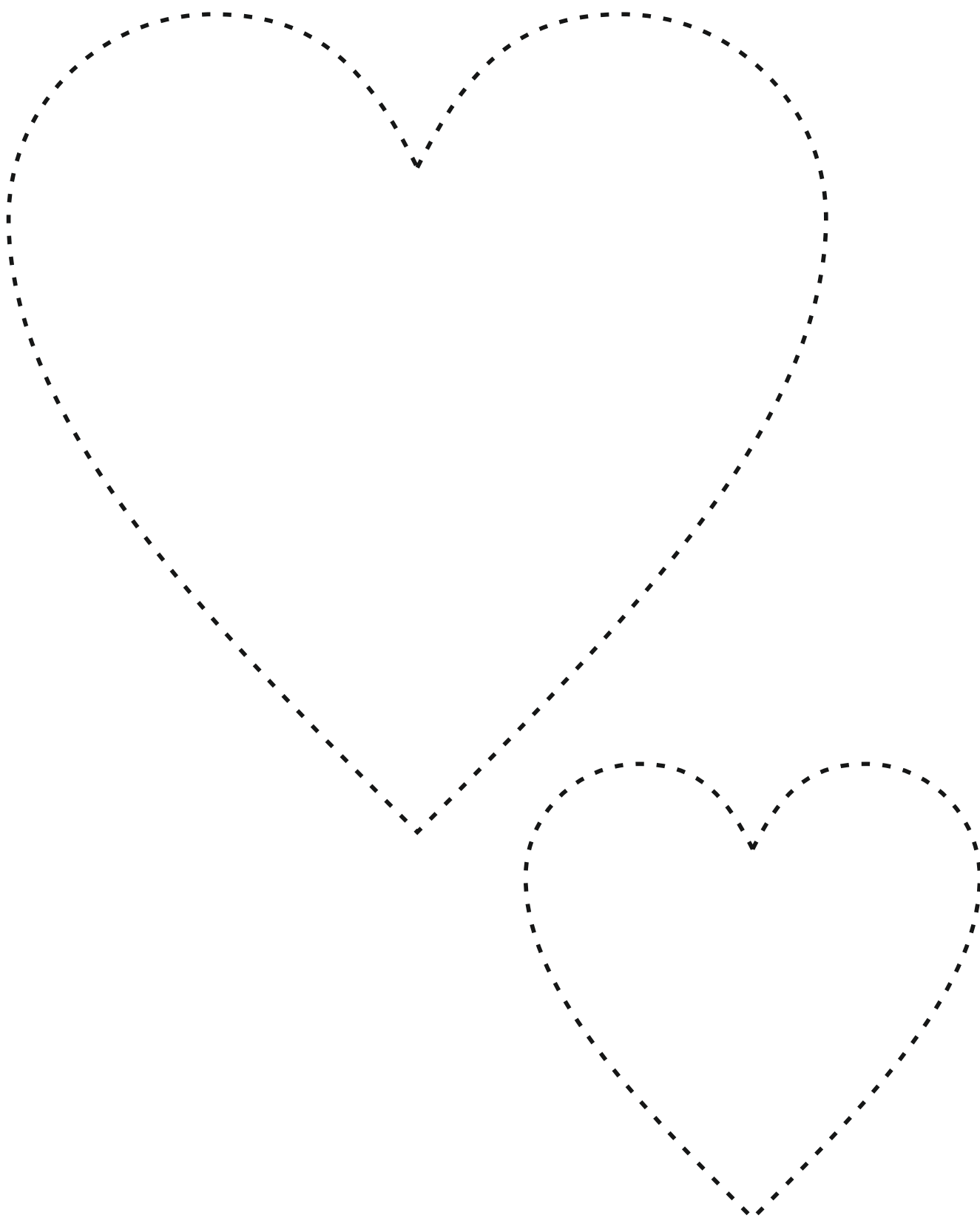

Narysuj pączka po śladzie i pokoloruj obrazek.

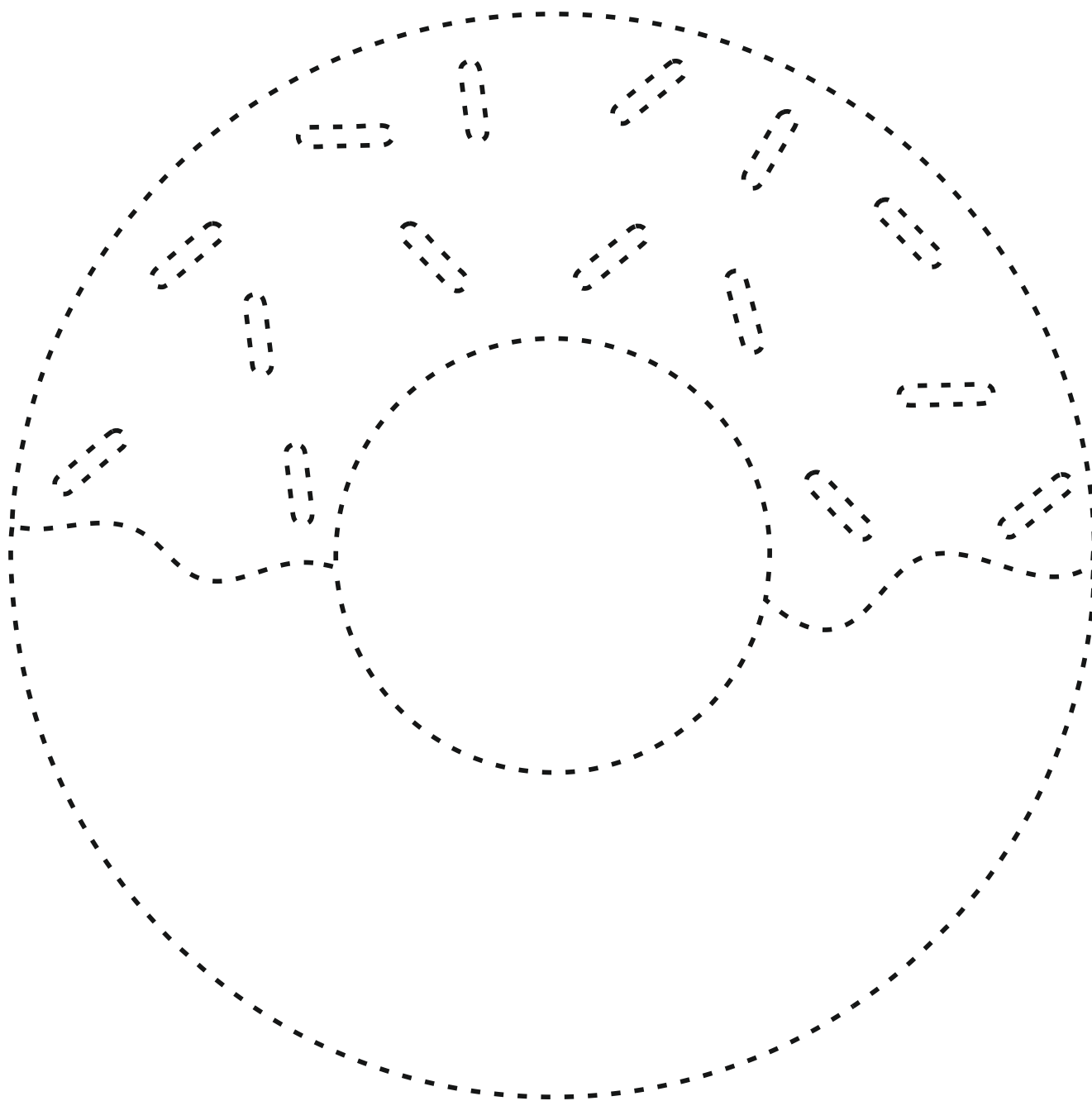

MARZEC

Narysuj pandę po śladzie, a następnie wyklej białą watą.



Narysuj krople wody po śladzie i pokoloruj obrazek.

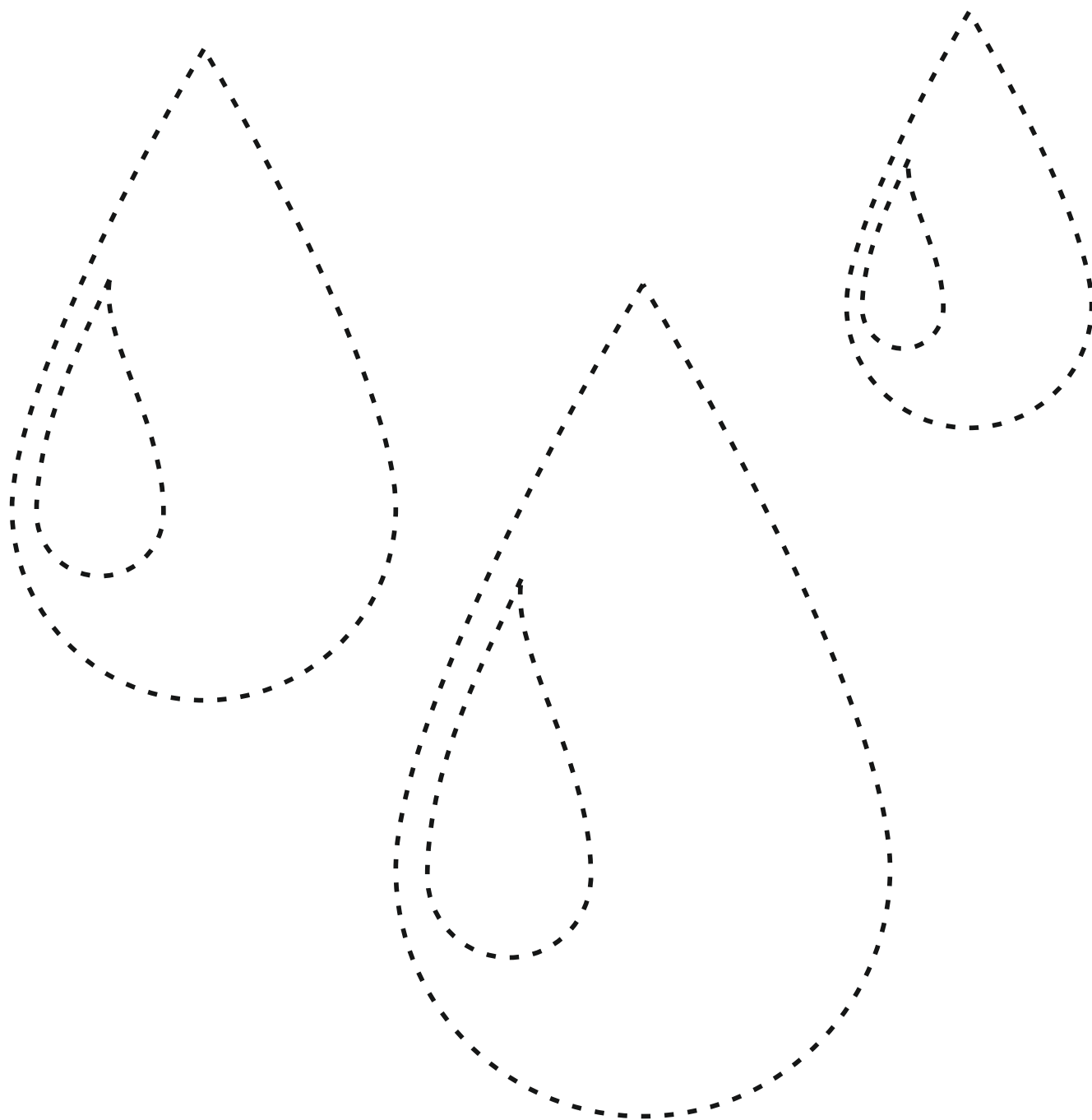

Narysuj po śladzie tor spadania kropelek wody.

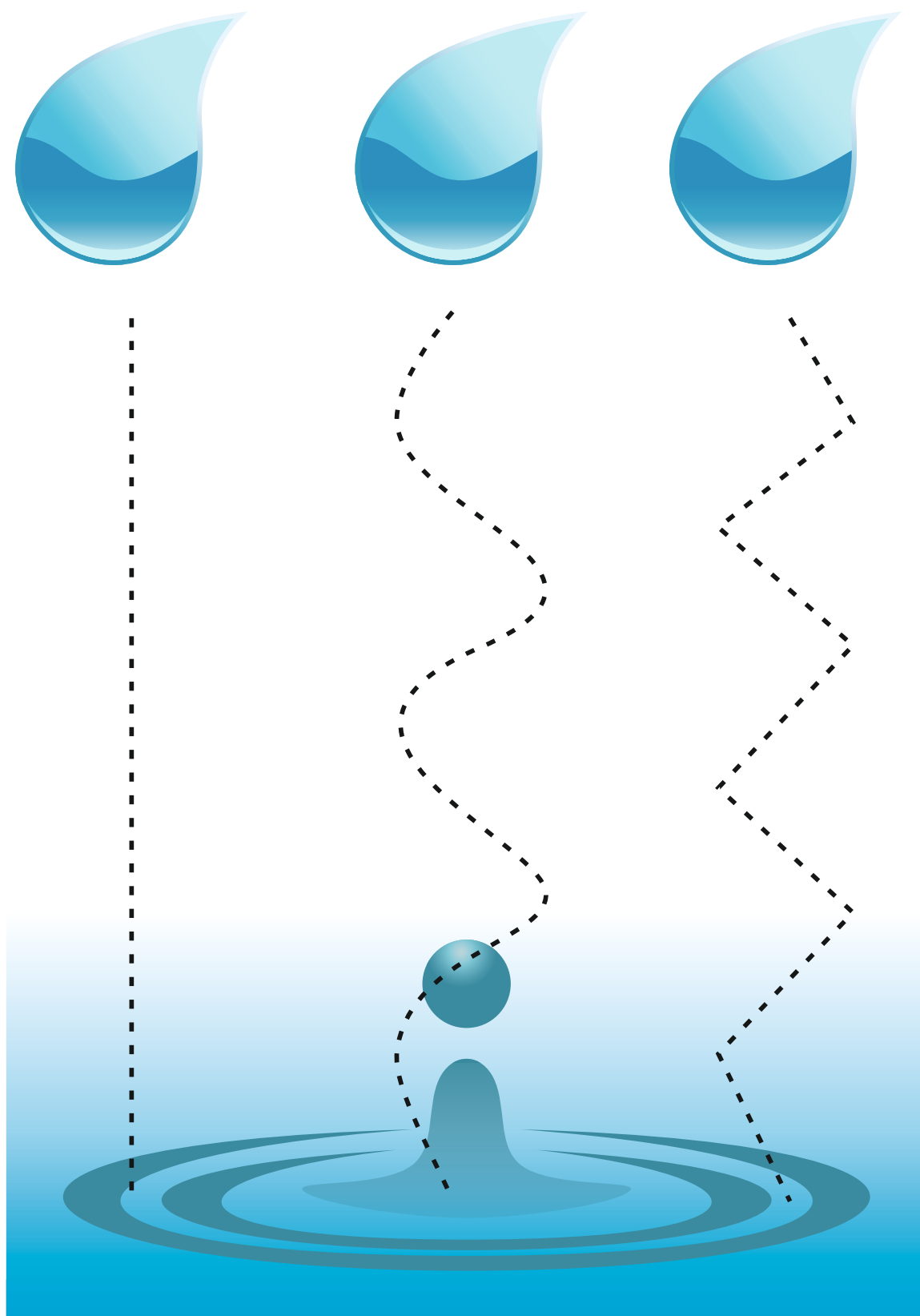

Narysuj po śladzie i pokoloruj obrazek.

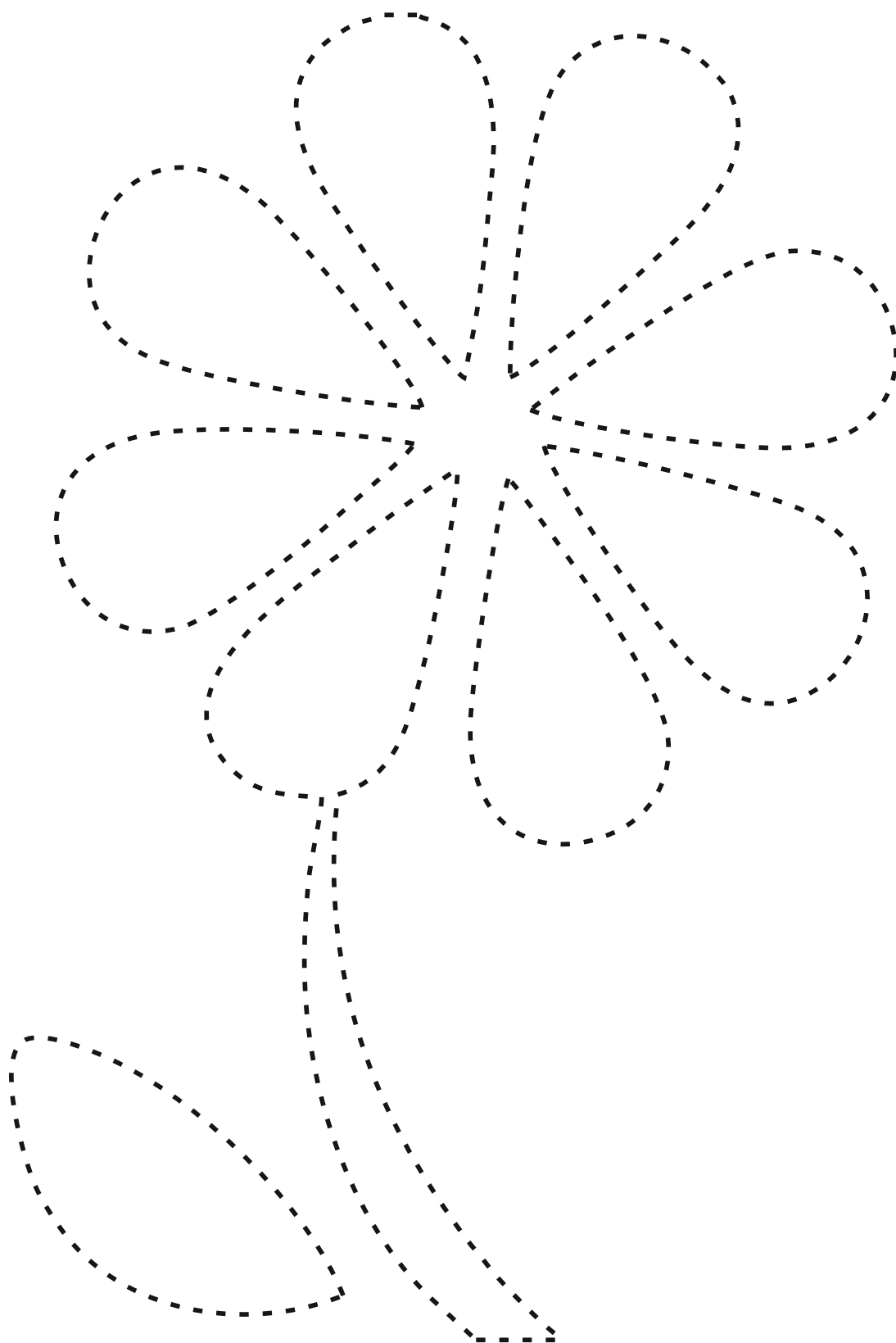

Narysuj jaskółki po śladzie i pokoloruj obrazek.

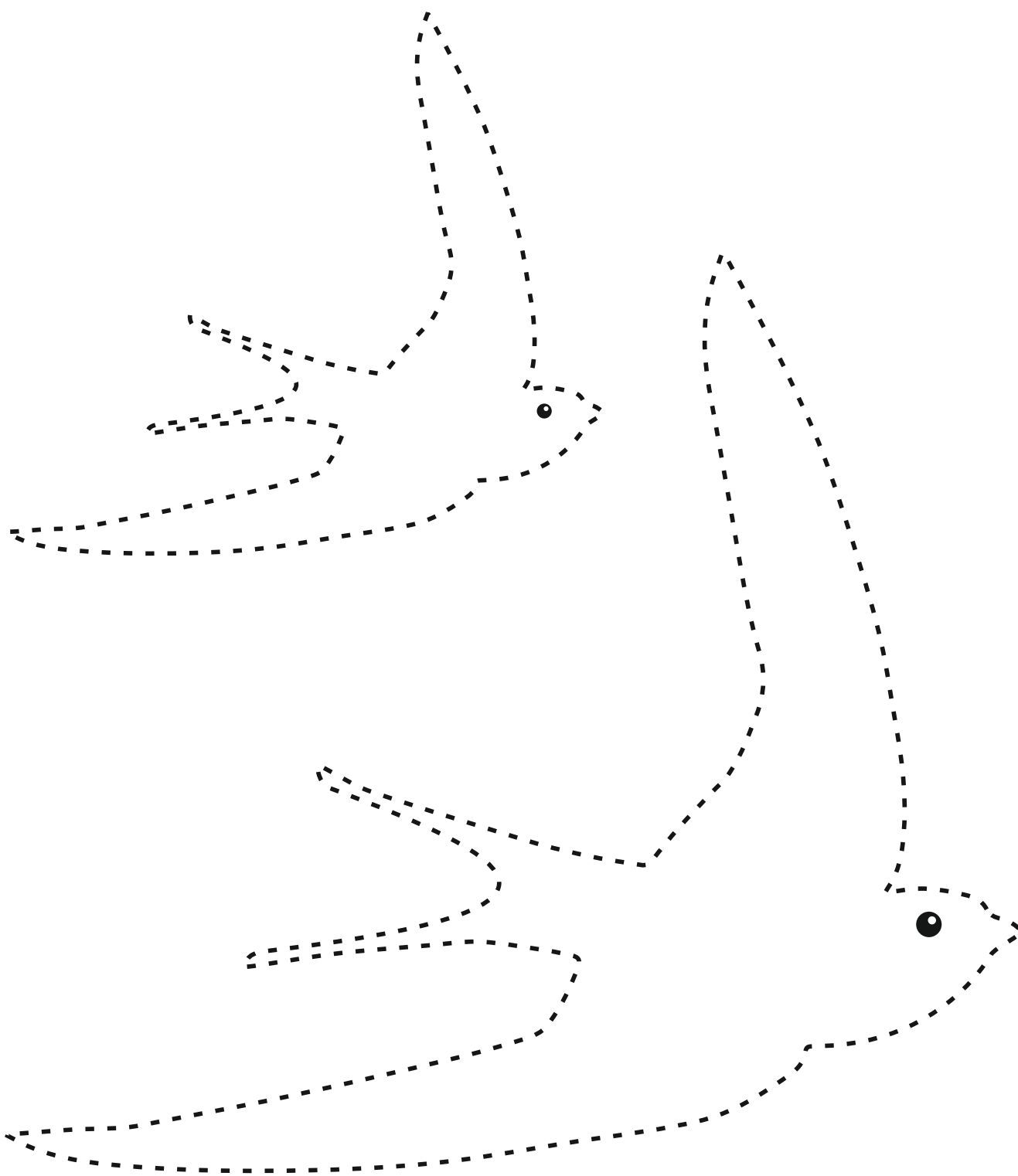

KWIECIEŃ

Narysuj po śladzie i pokoloruj obrazek.

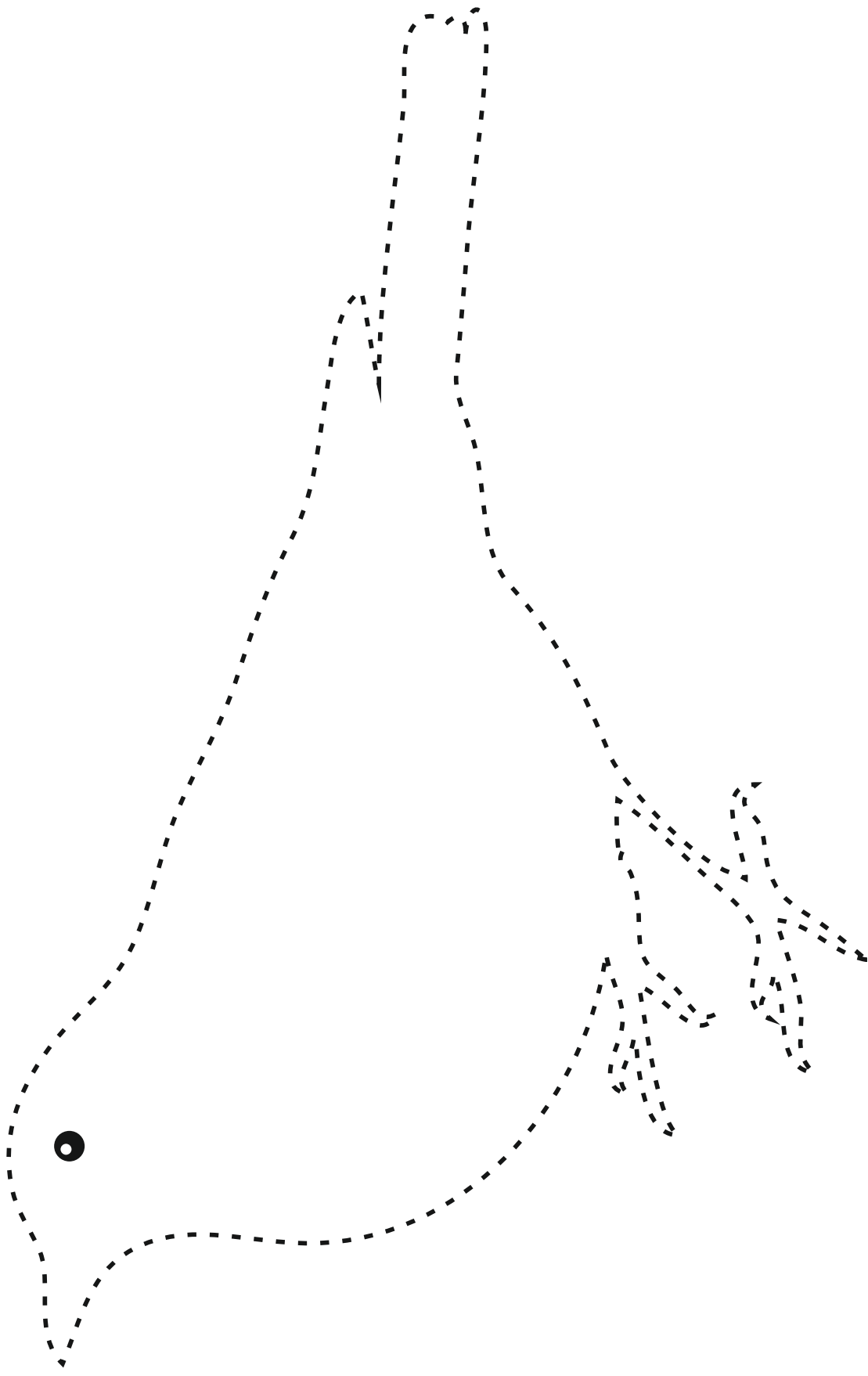

Narysuj linie po śladzie i doprowadź ptaszka do gniazda.

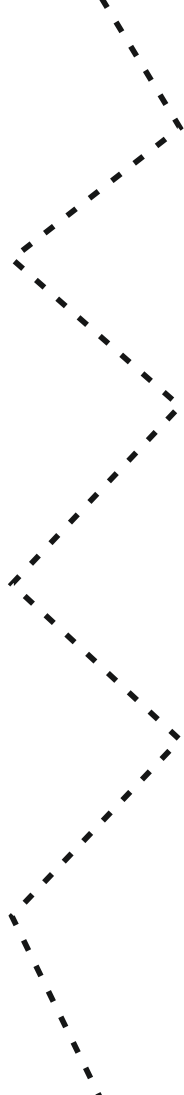
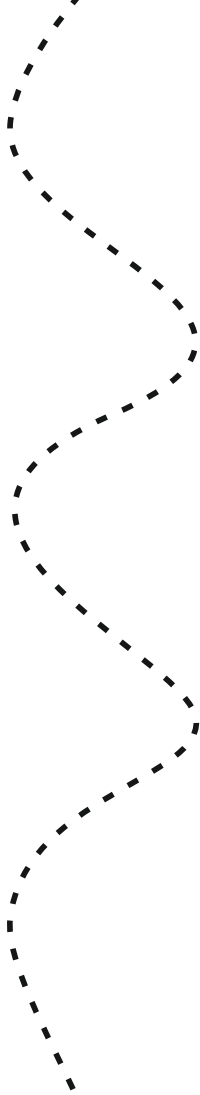

Narysuj po śladzie i pokoloruj obrazek.

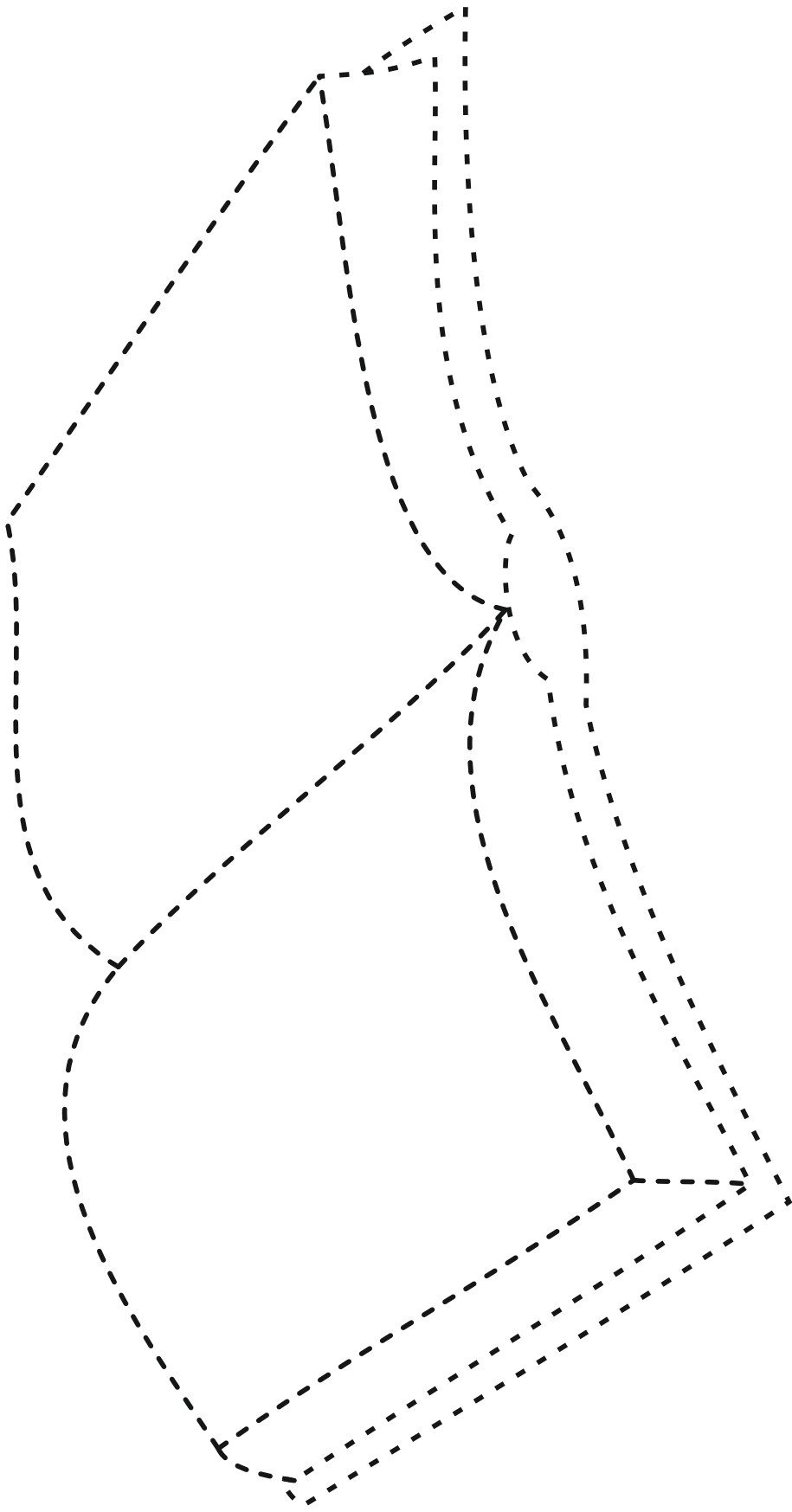

Stwórz zakładkę do książki. Narysuj po śladzie i pokoloruj obrazek.

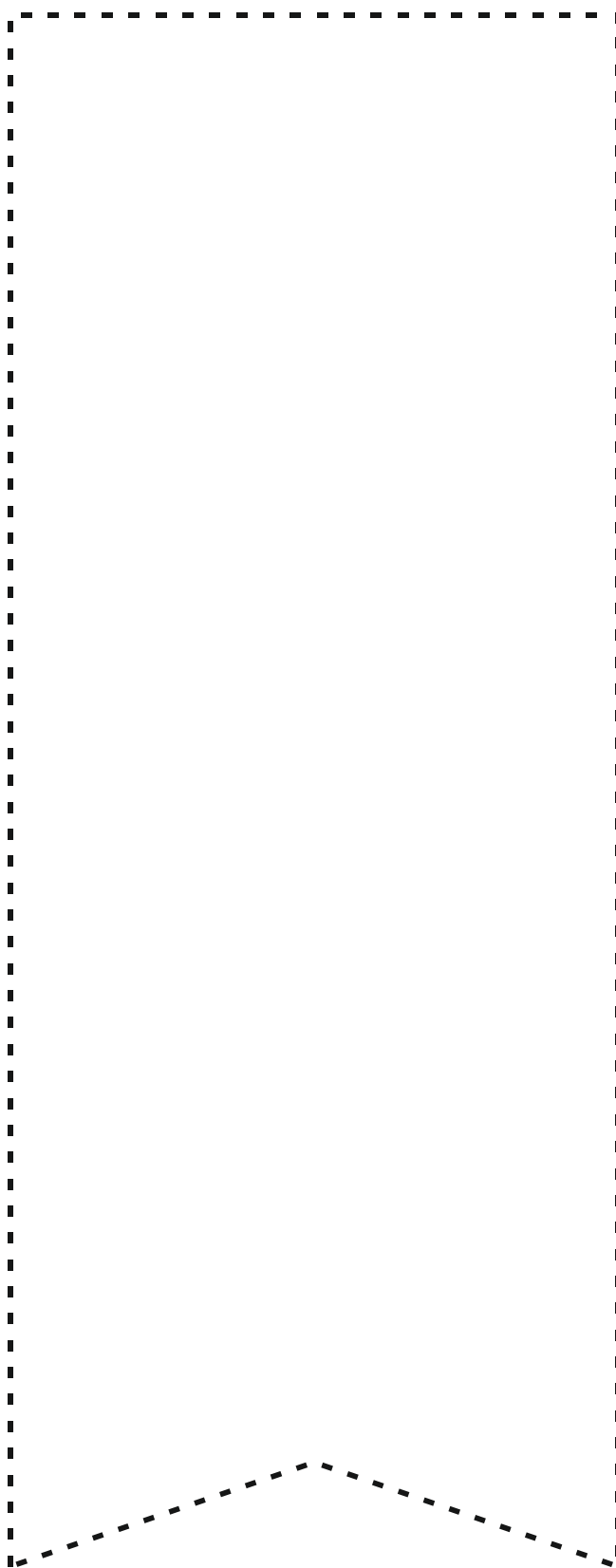

Narysuj tabliczkę czekolady po śladzie, a następnie pomaluj farbami.

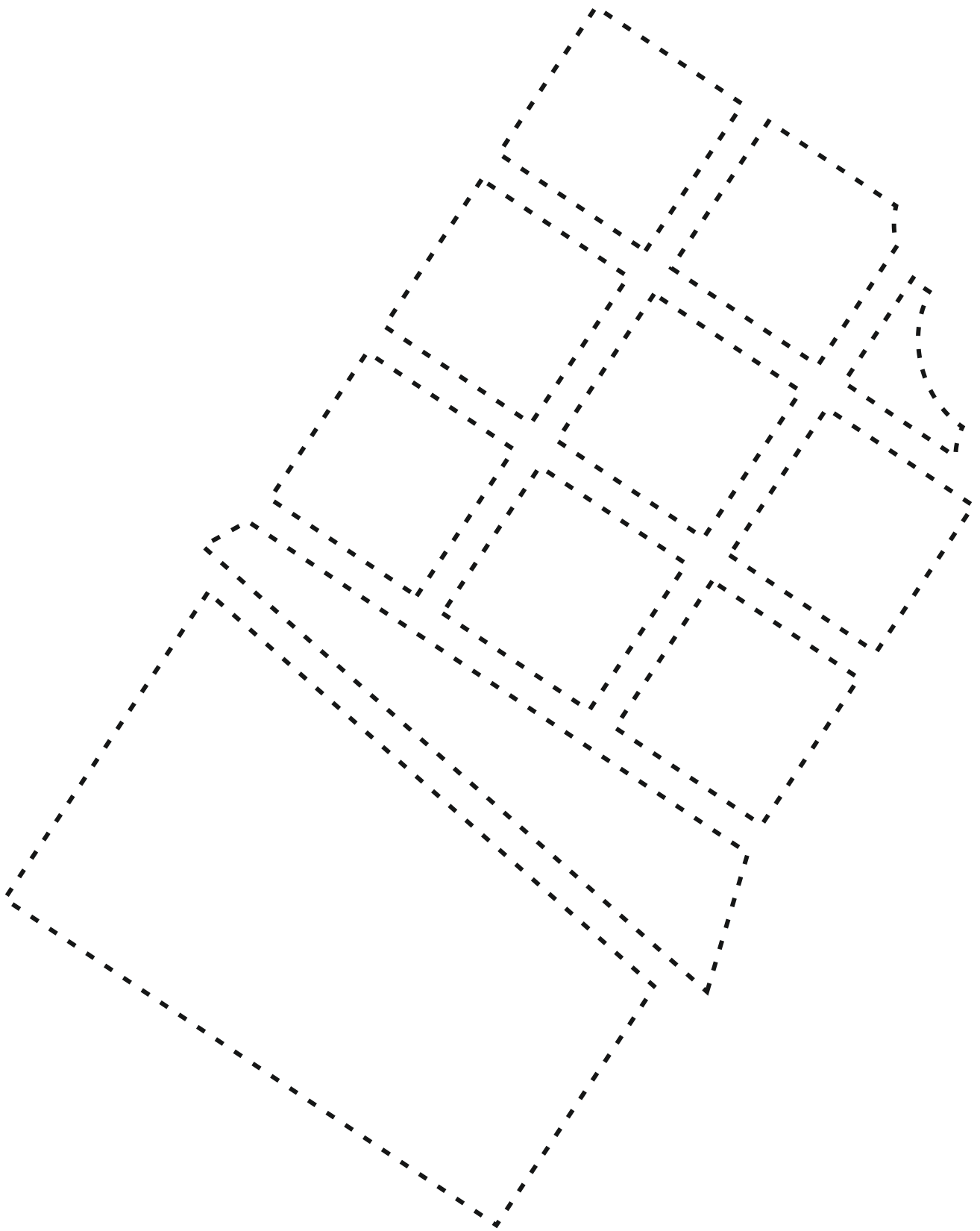

Narysuj linie po śladzie i sprawdź jaki smak czekolady lubią dzieci.

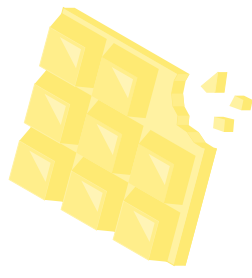
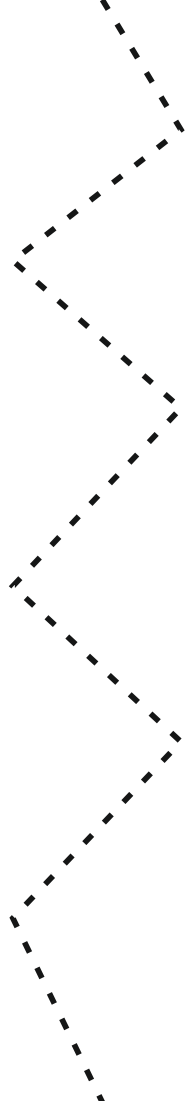
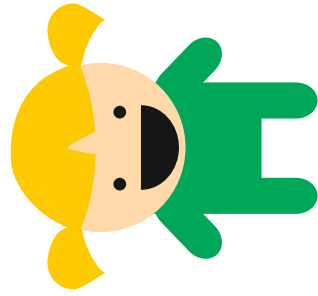
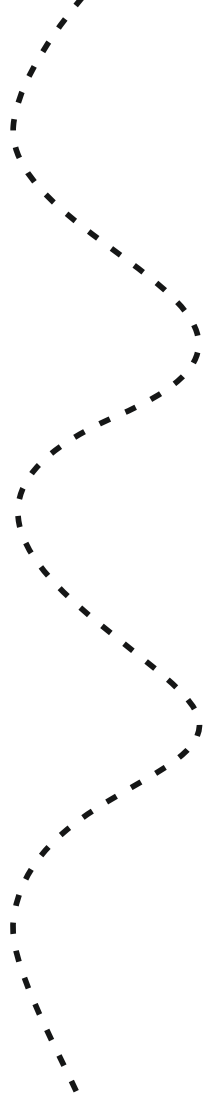
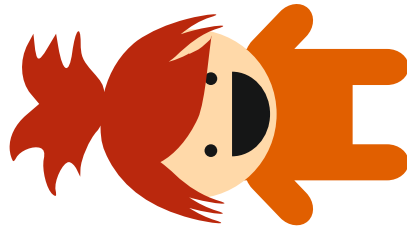
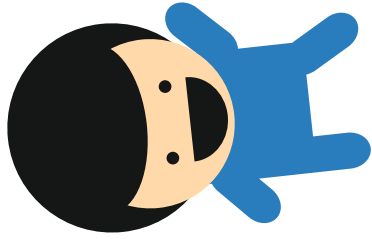

Narysuj po śladzie i pokoloruj obrazek.

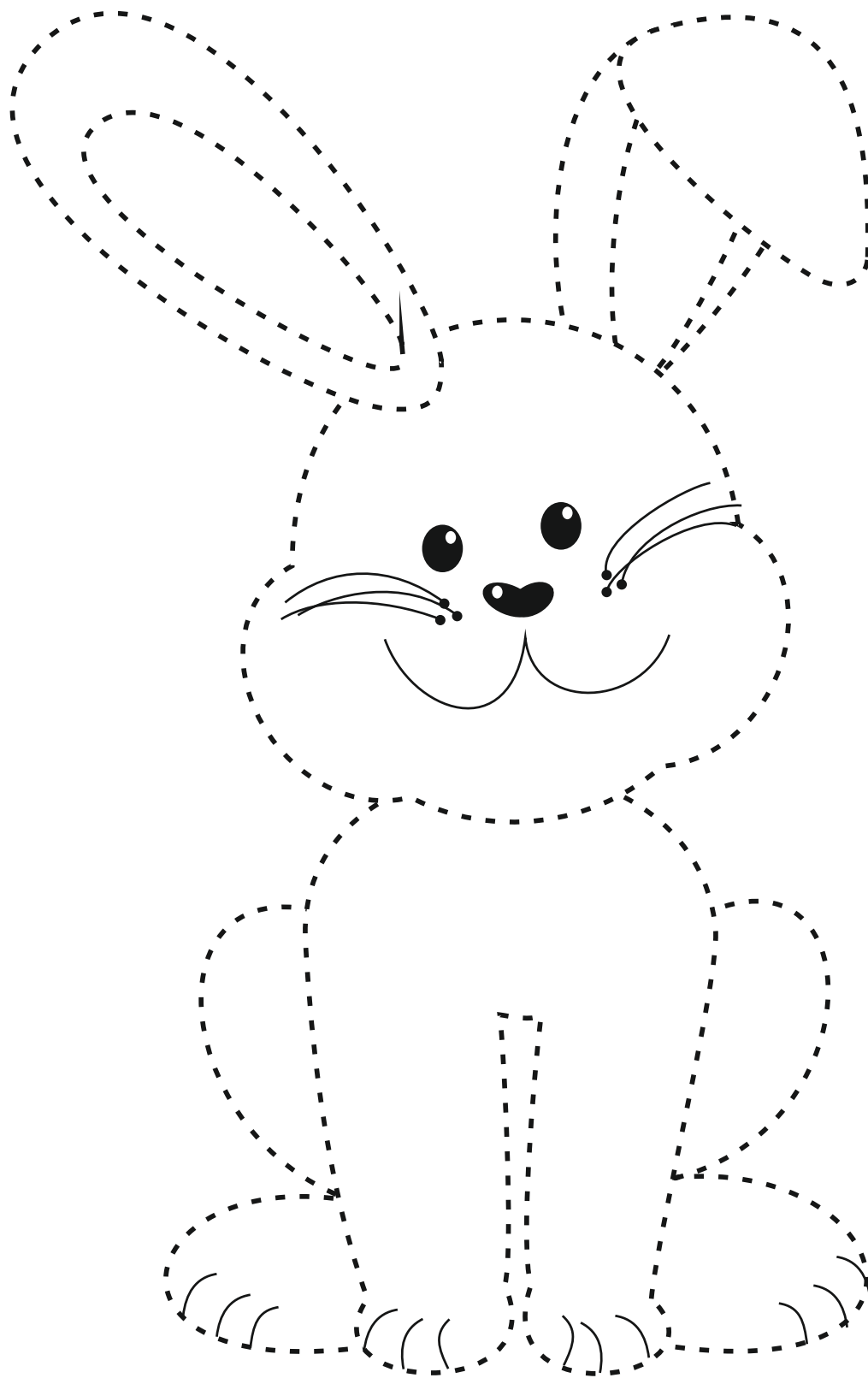

Narysuj baranka po śladzie, a następnie wyklej białą watą.

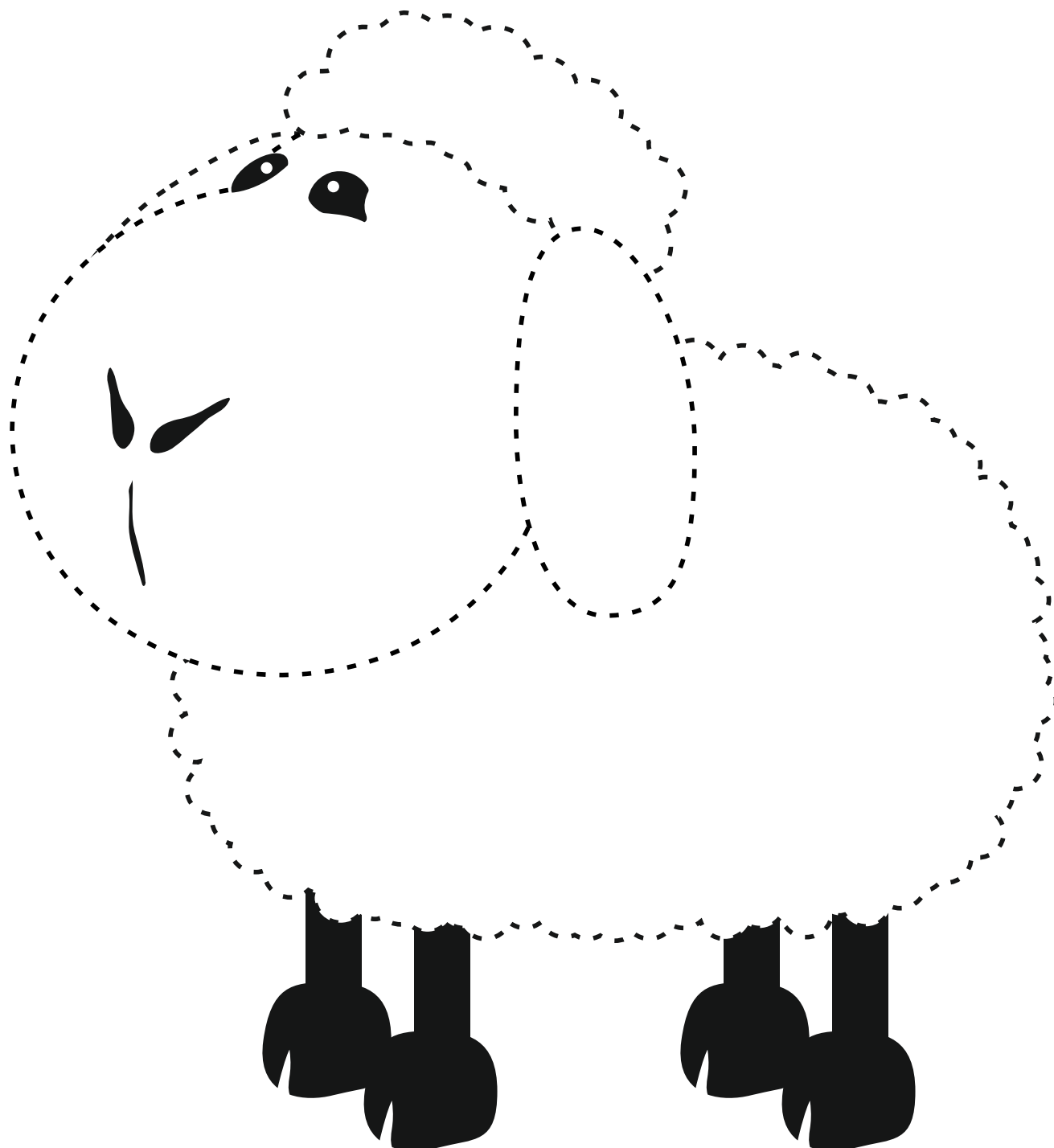

Narysuj pisanekę po śladzie i ozdób ją używając ulubionych kolorów.

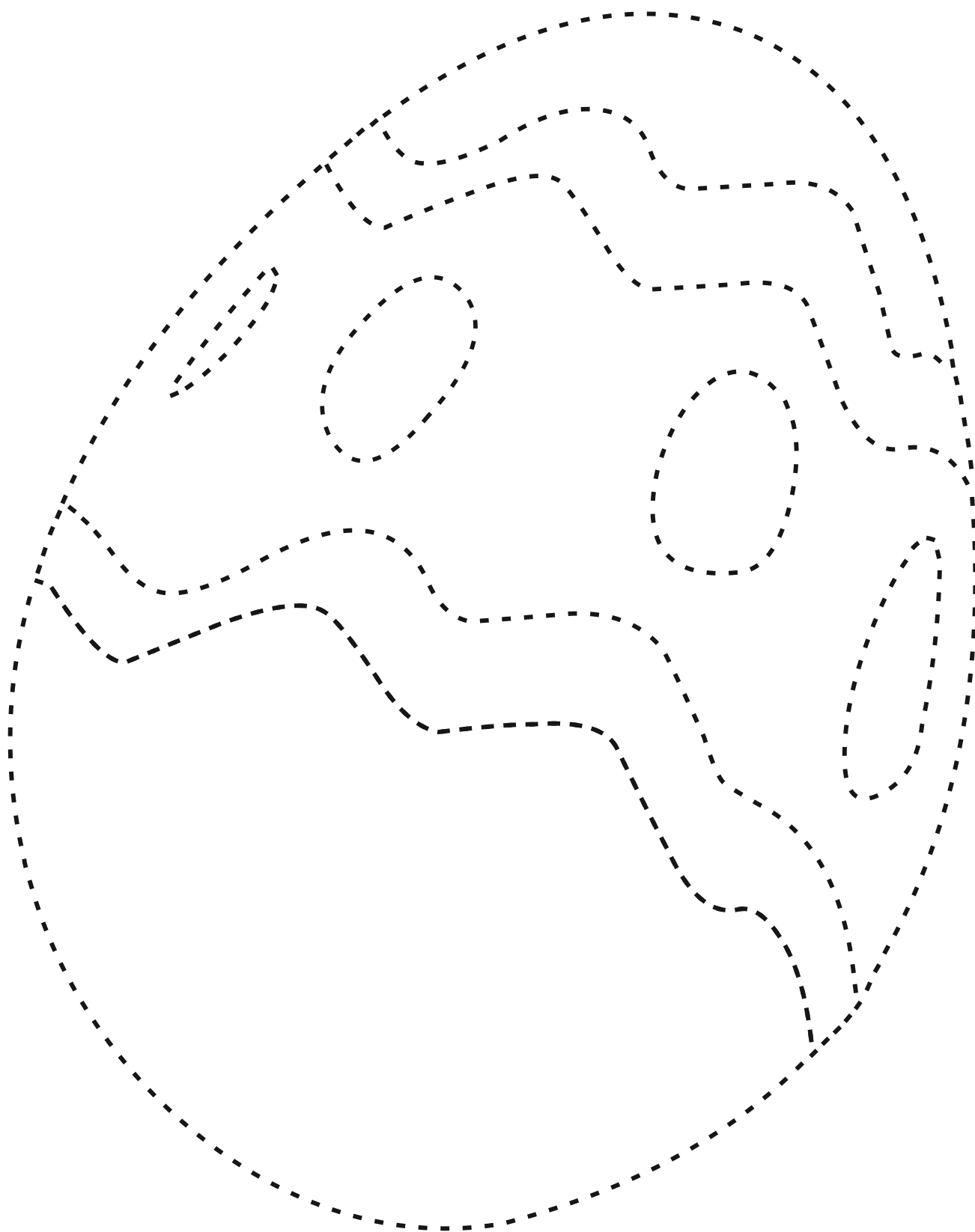

MAJ

Narysuj strażaka po śladzie i pokoloruj obrazek.

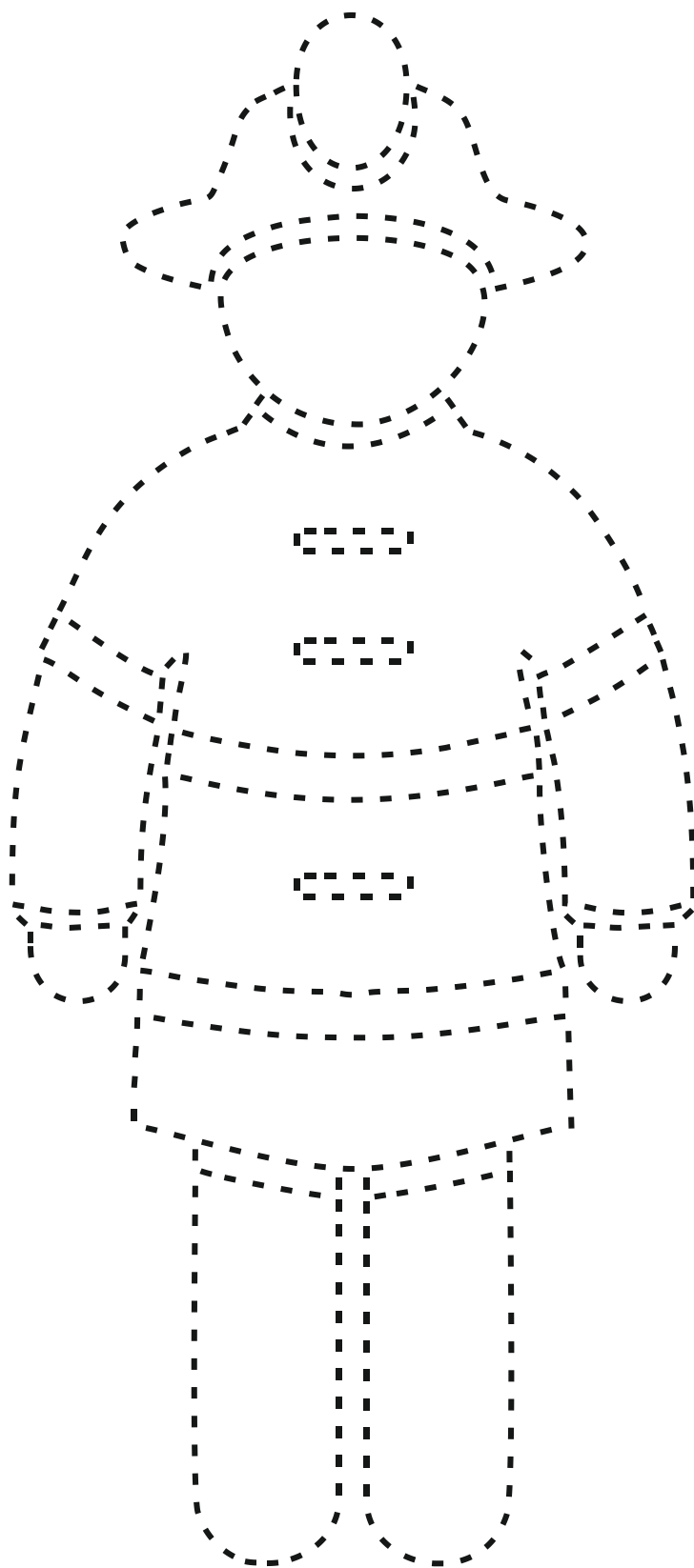

Narysuj wóz strażacki po śladzie i pokoloruj obrazek.

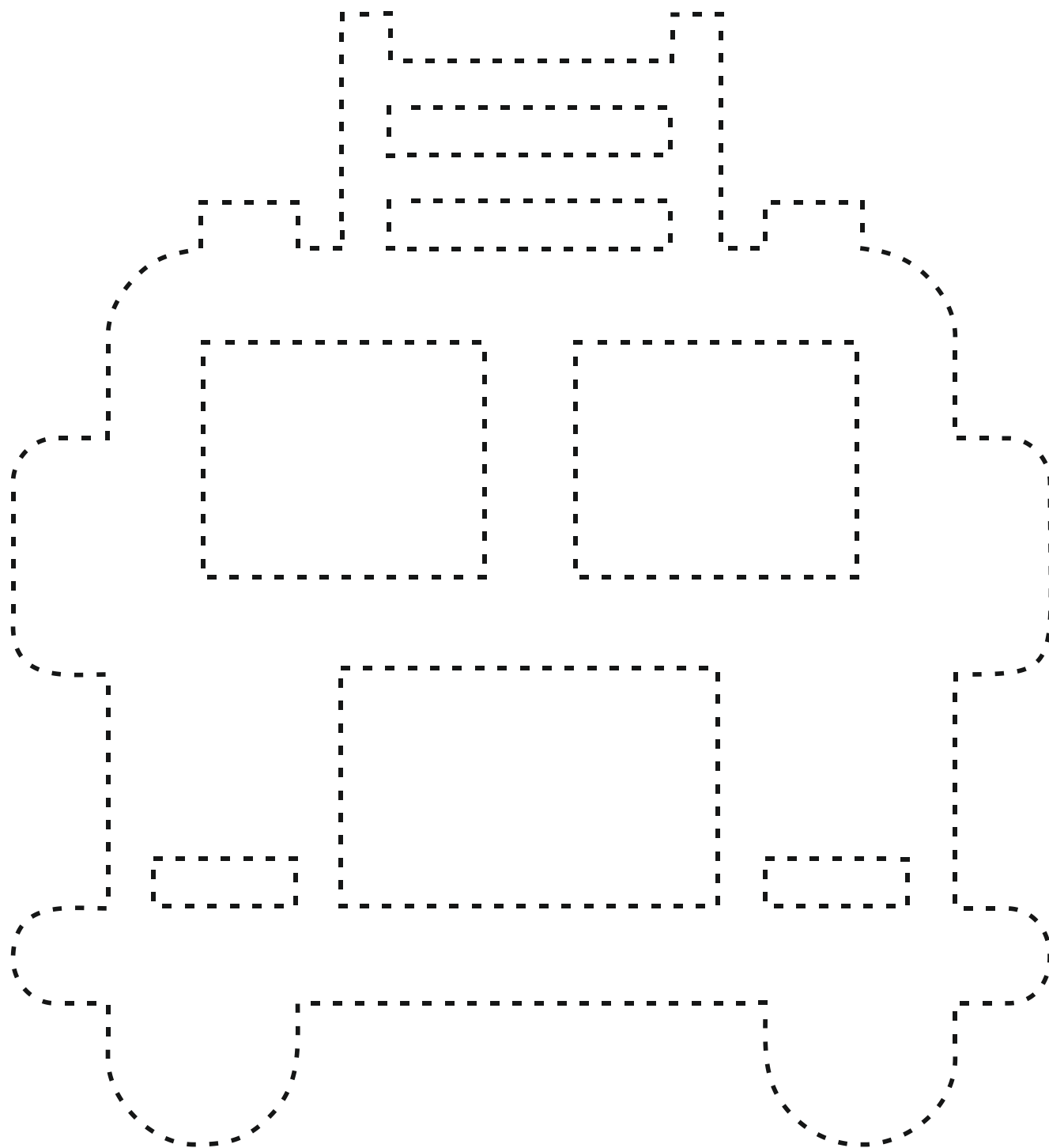

Narysuj linie po śladzie i doprowadź strażaka do wozu strażackiego.

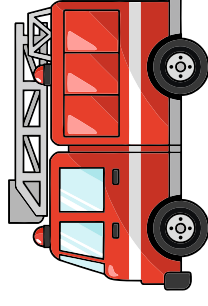
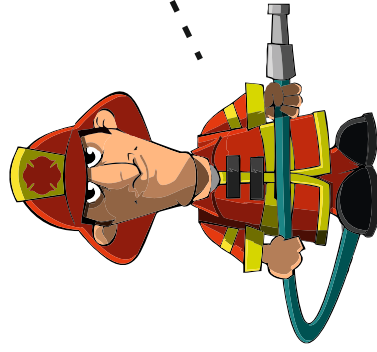
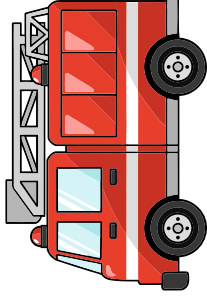
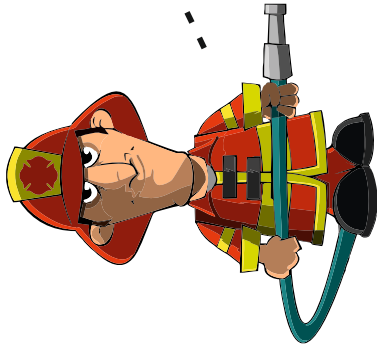
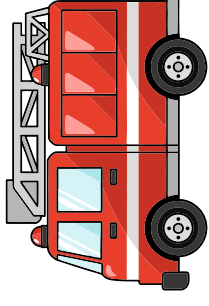
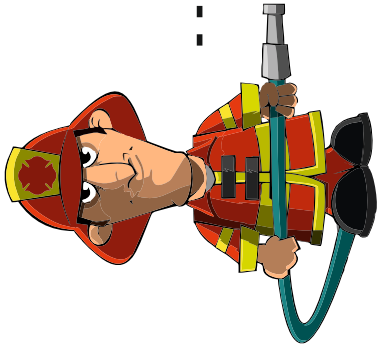

Narysuj po śladzie i wyklej plasteliną.

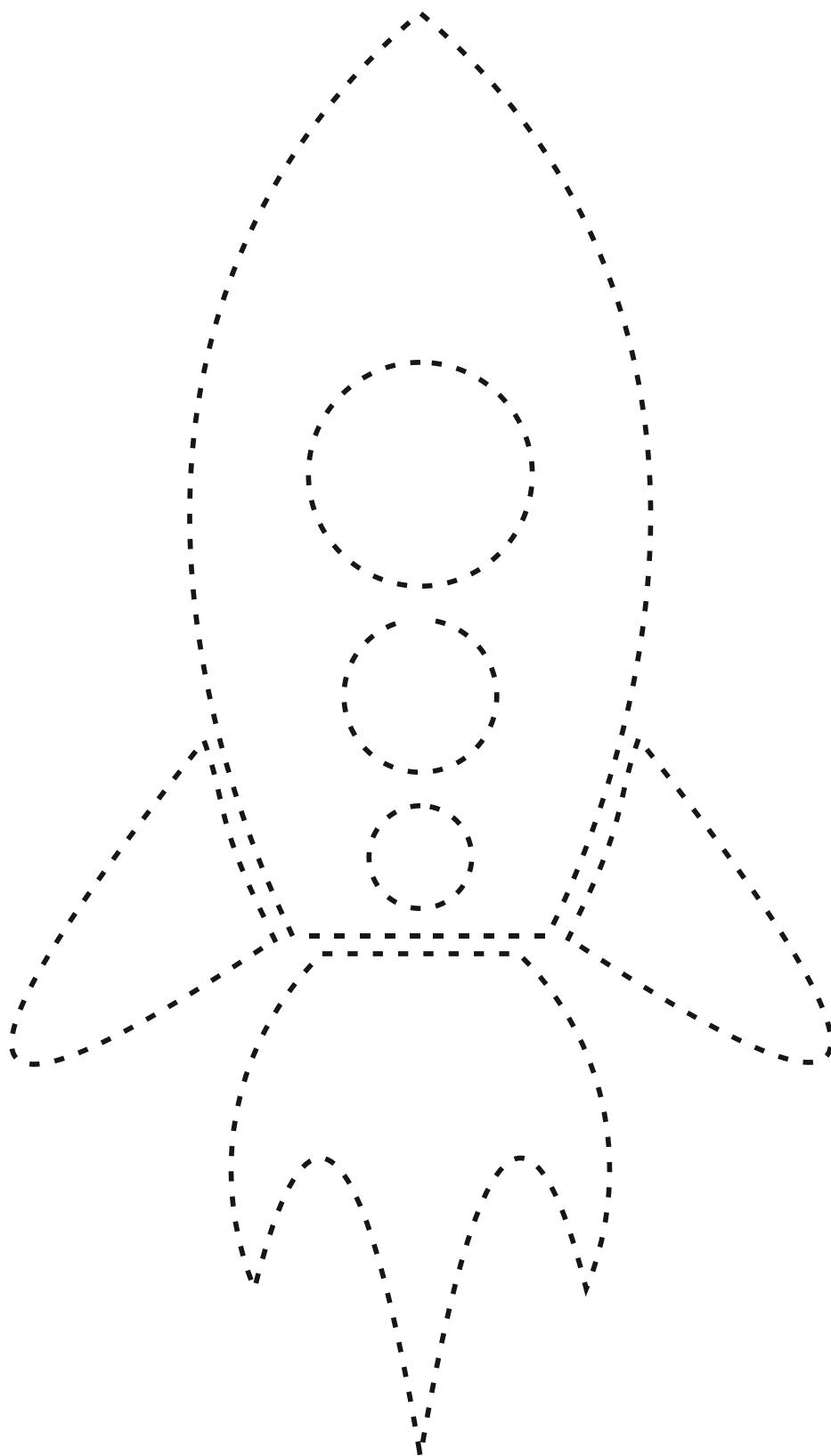

Narysuj planetę Saturn po śladzie i pokoloruj obrazek.

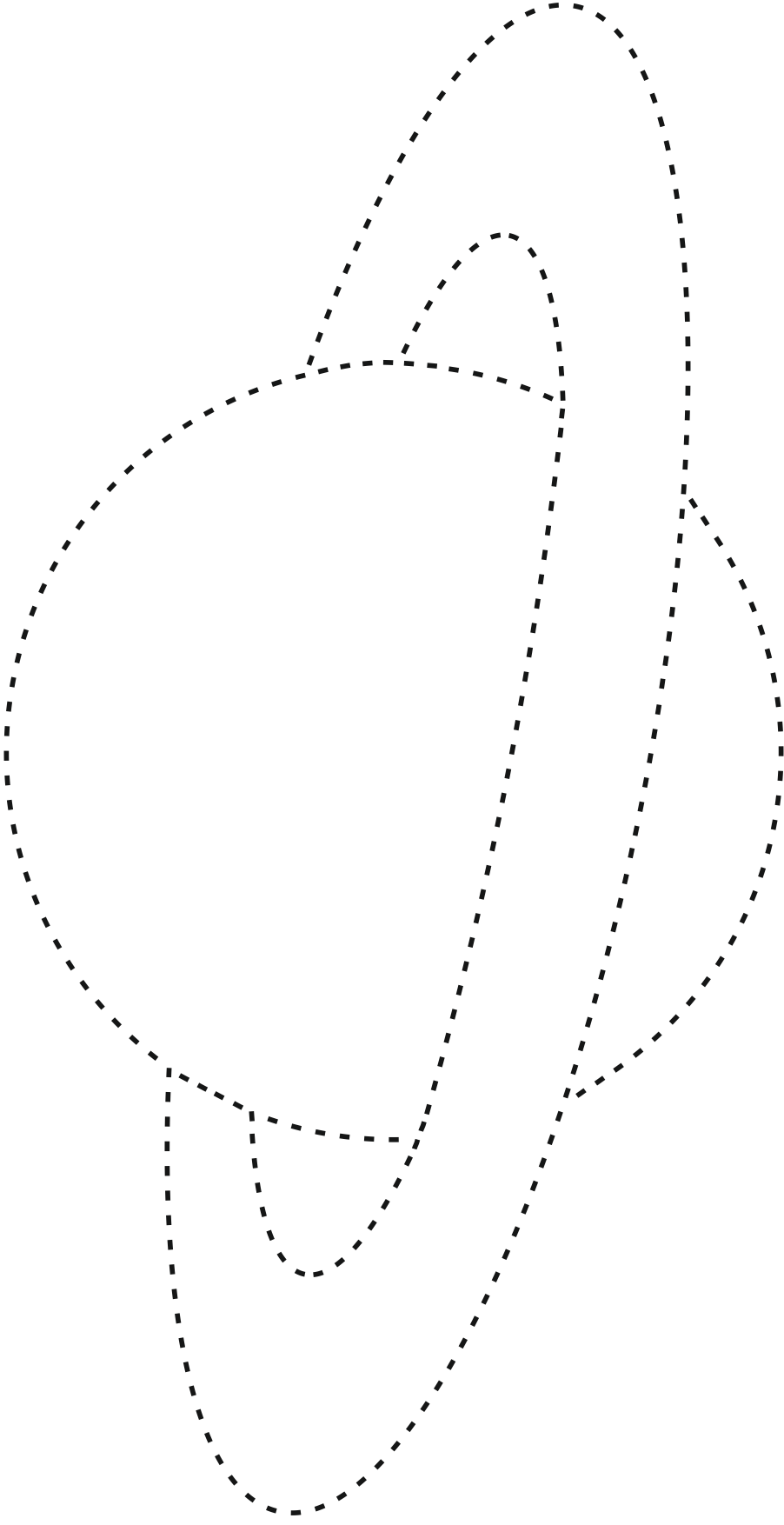

Narysuj po śladzie, a następnie pokoloruj cały obrazek.

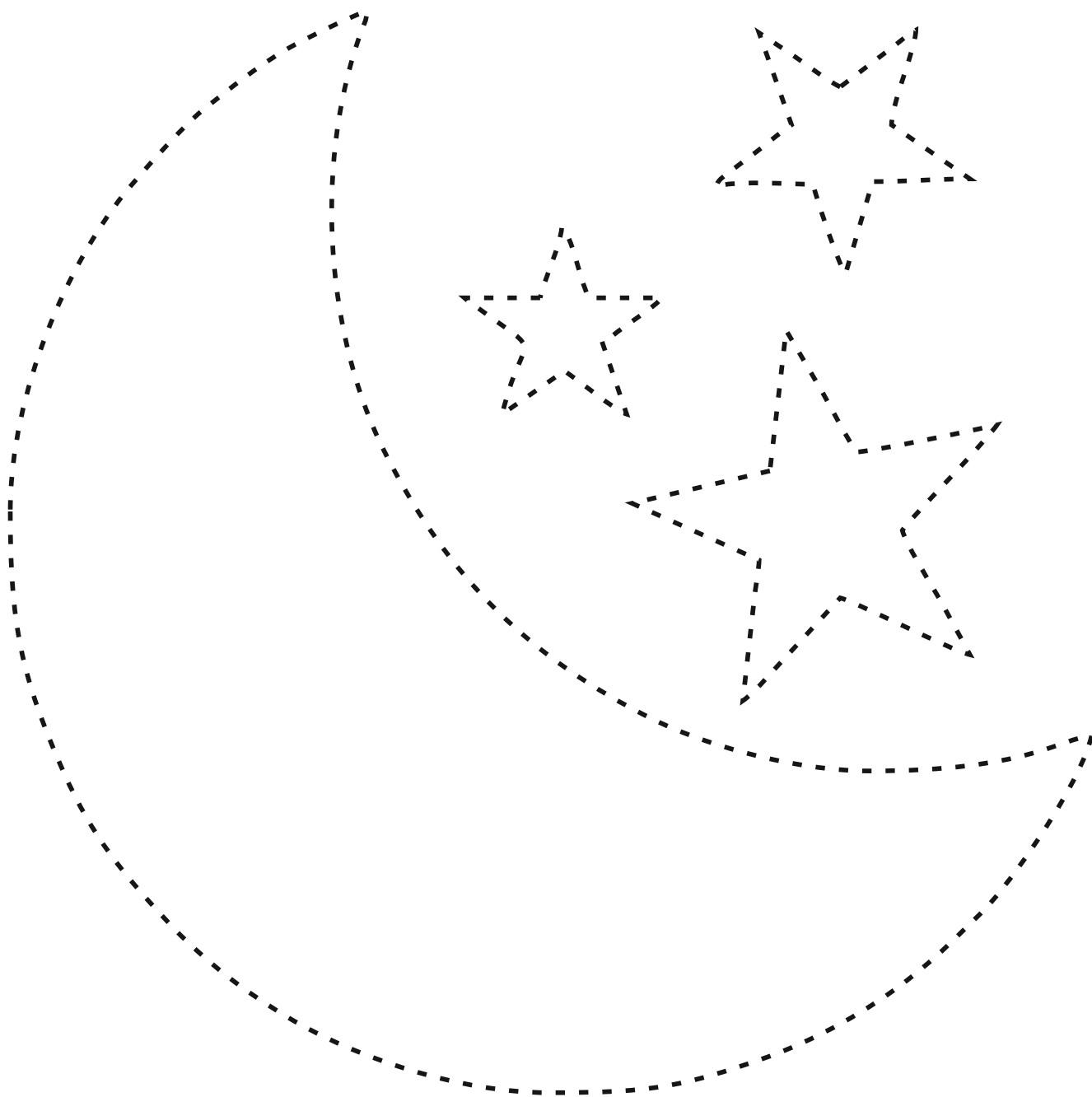

Narysuj bociana po śladzie i pokoloruj obrazek.

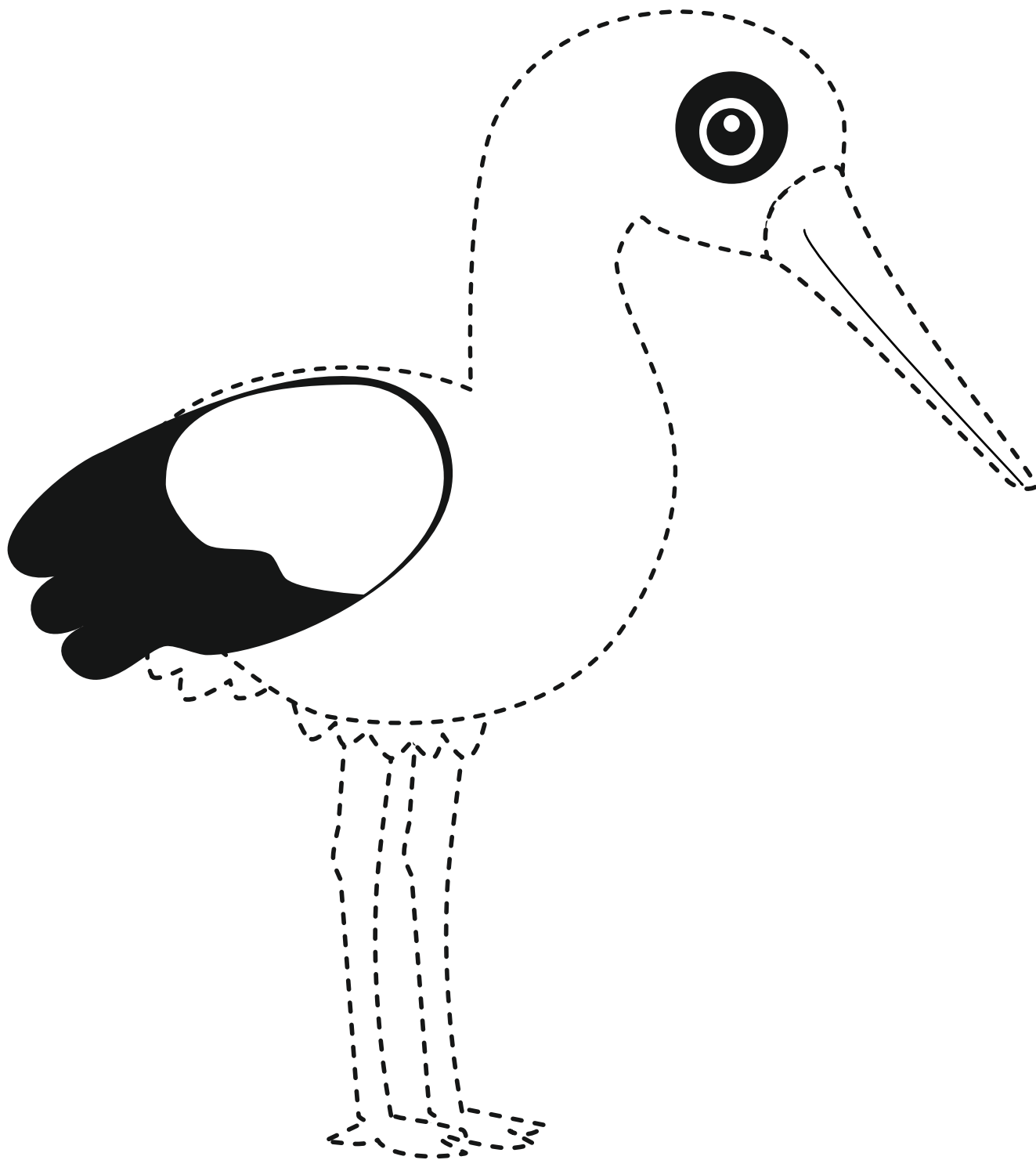

Narysuj flagę Polski na maszcie po śladzie i pokoloruj obrazek.

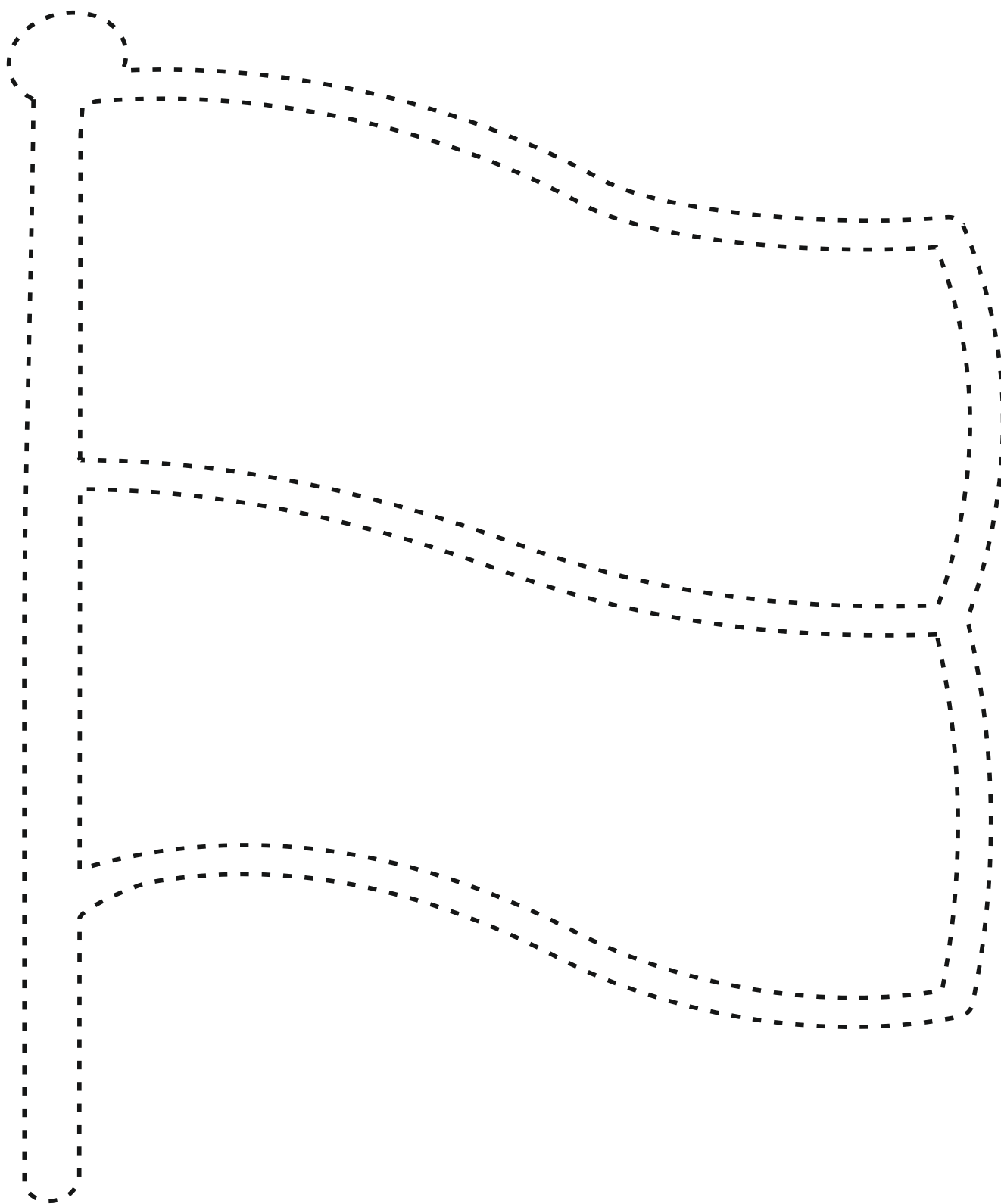

Stwórz laurkę dla mamy. Narysuj tulipana po śladzie i pomaluj farbami.

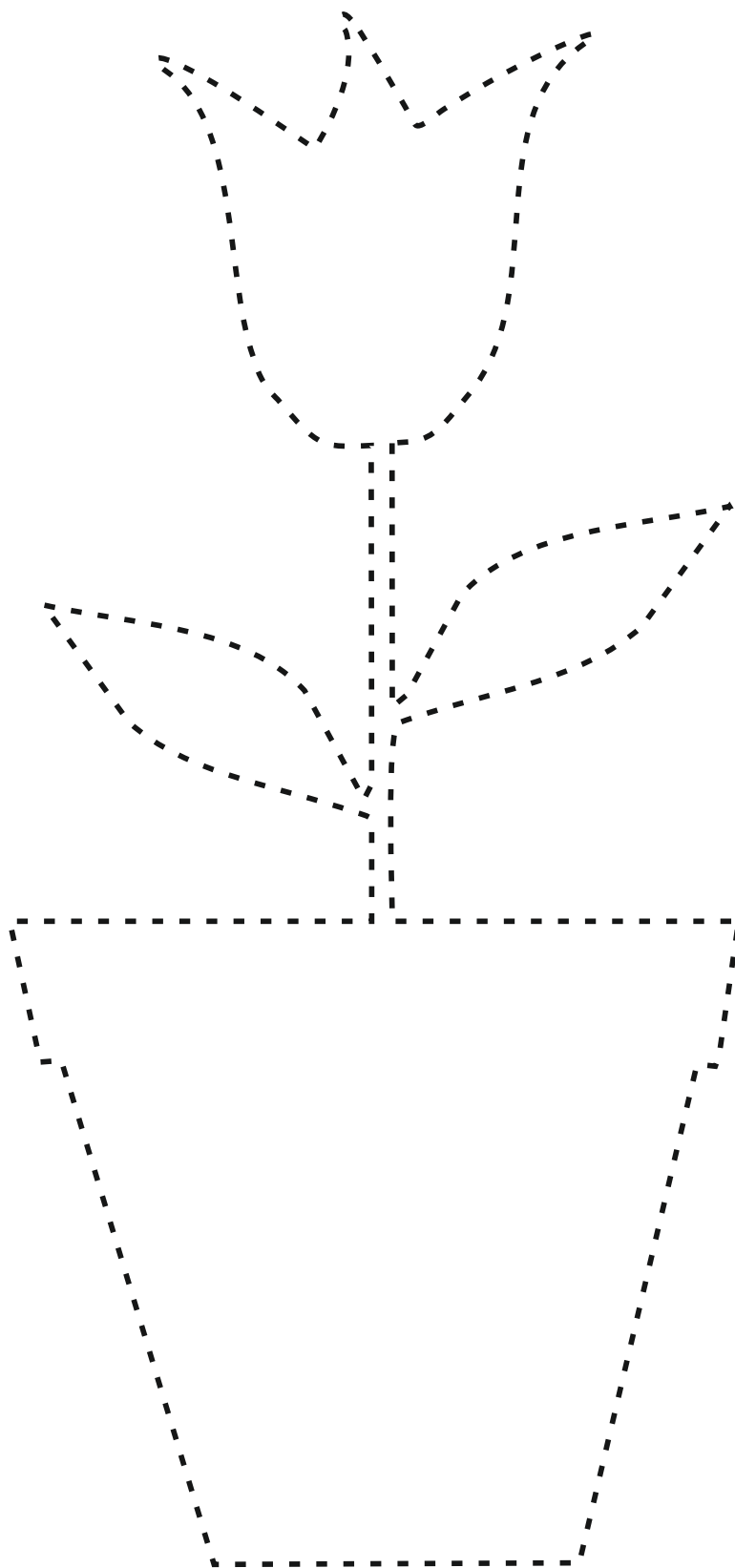

CZERWIEC

Narysuj koło ratunkowe po śladzie i pokoloruj obrazek.

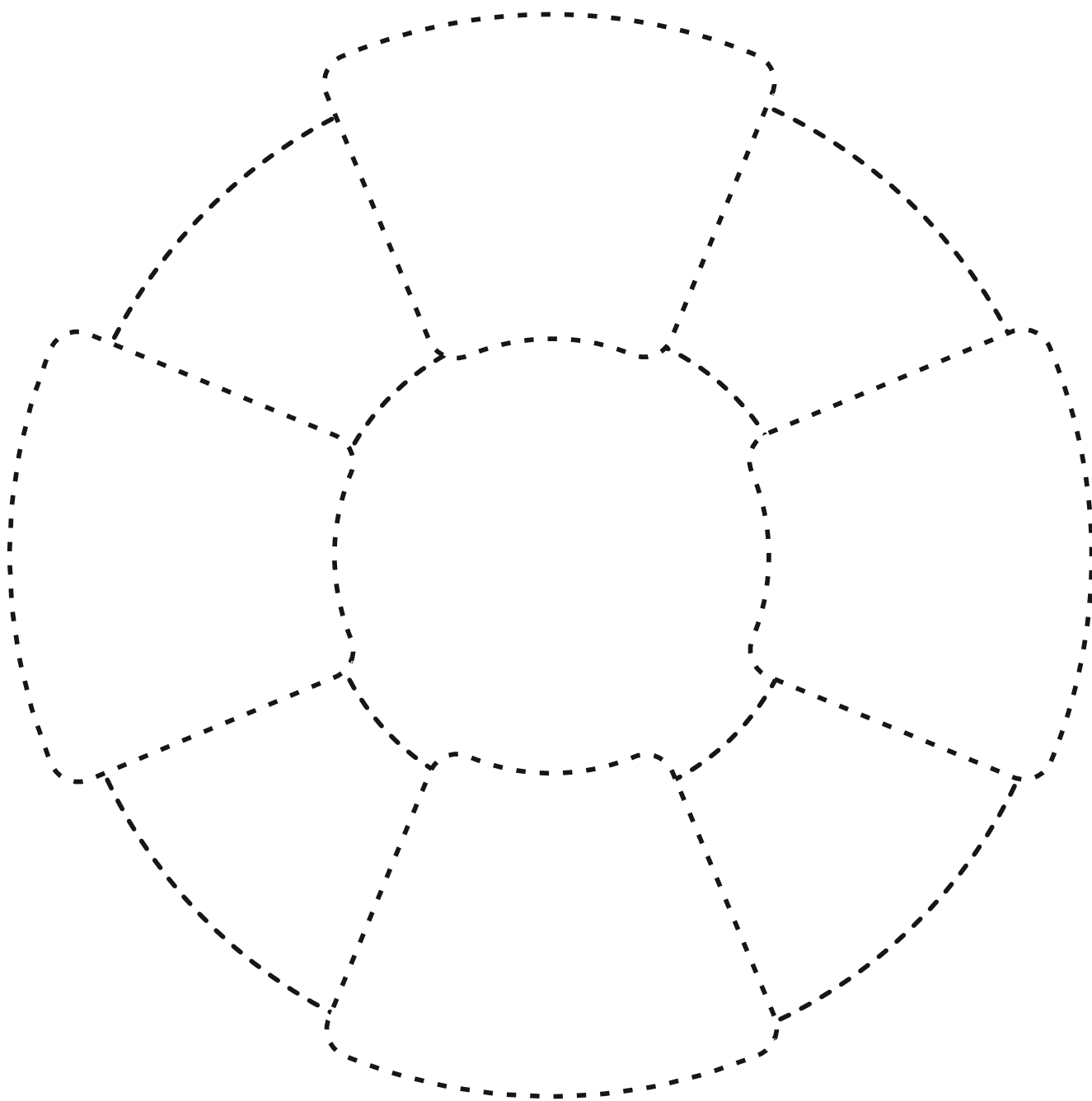

Narysuj po śladzie i pokoloruj obrazek.

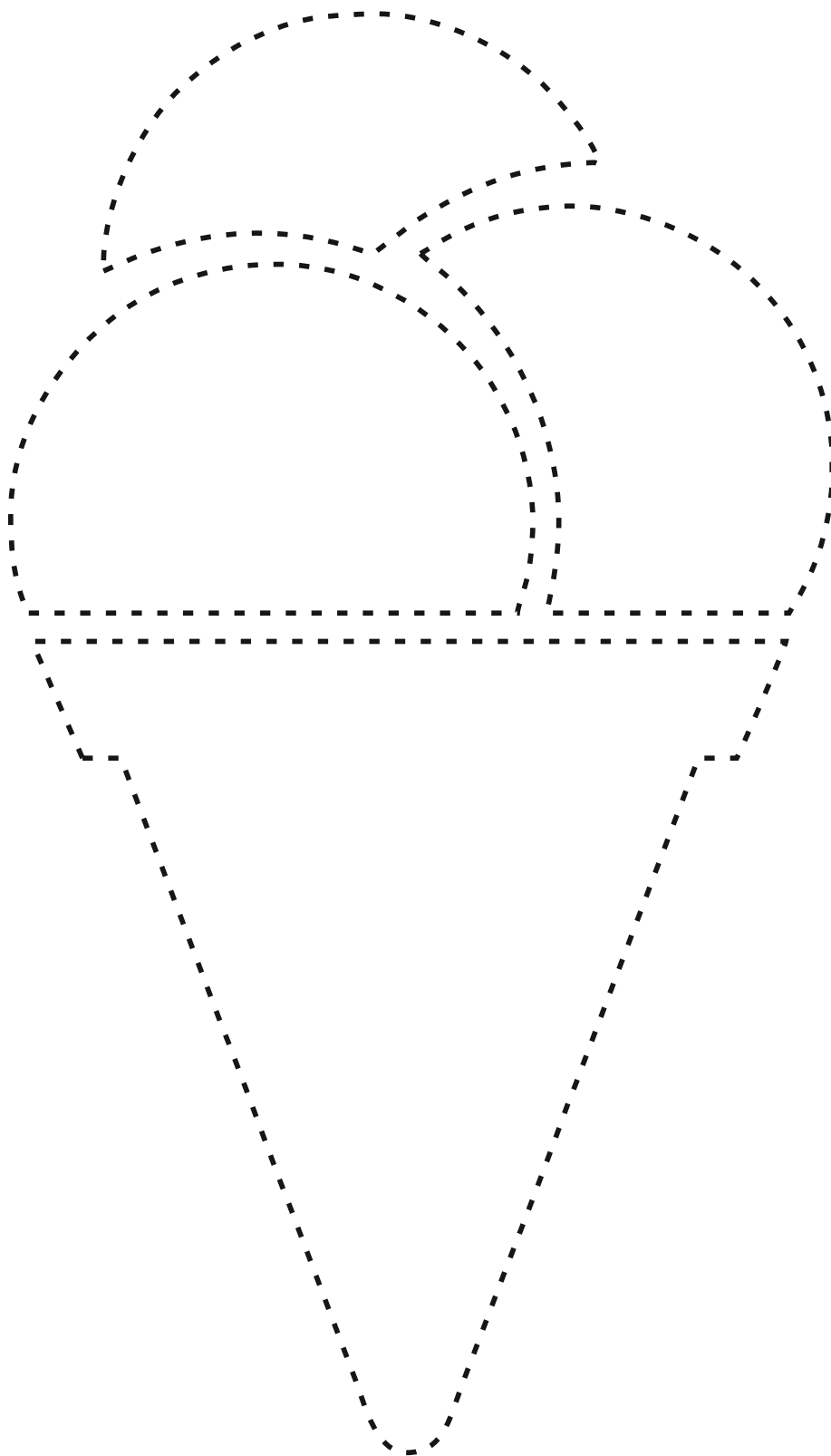

Narysuj linie po śladzie i sprawdź jaki rodzaj lodów lubią dzieci.

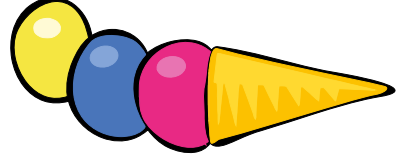
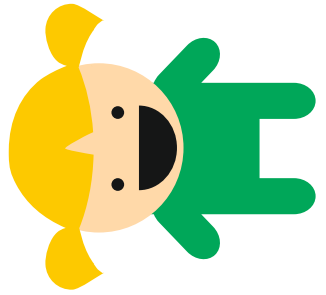
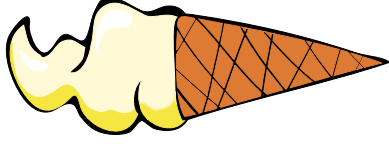
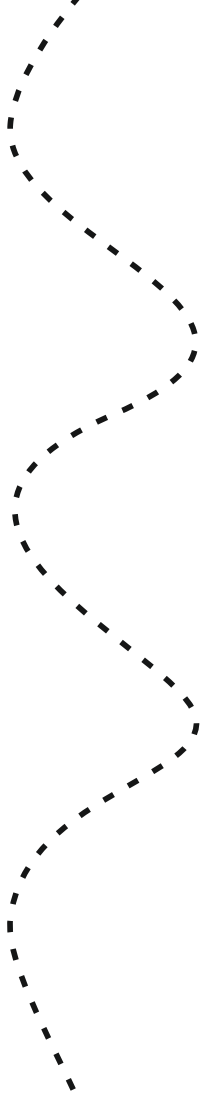
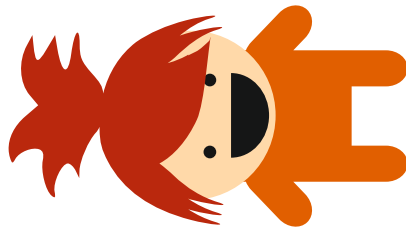
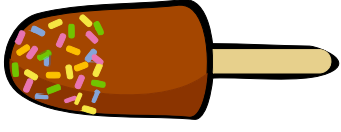
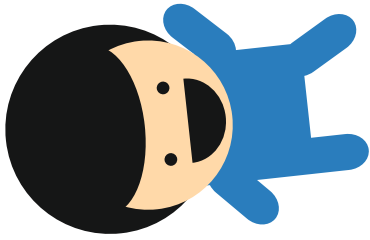

Narysuj słońce po śladzie i pomaluj farbami.

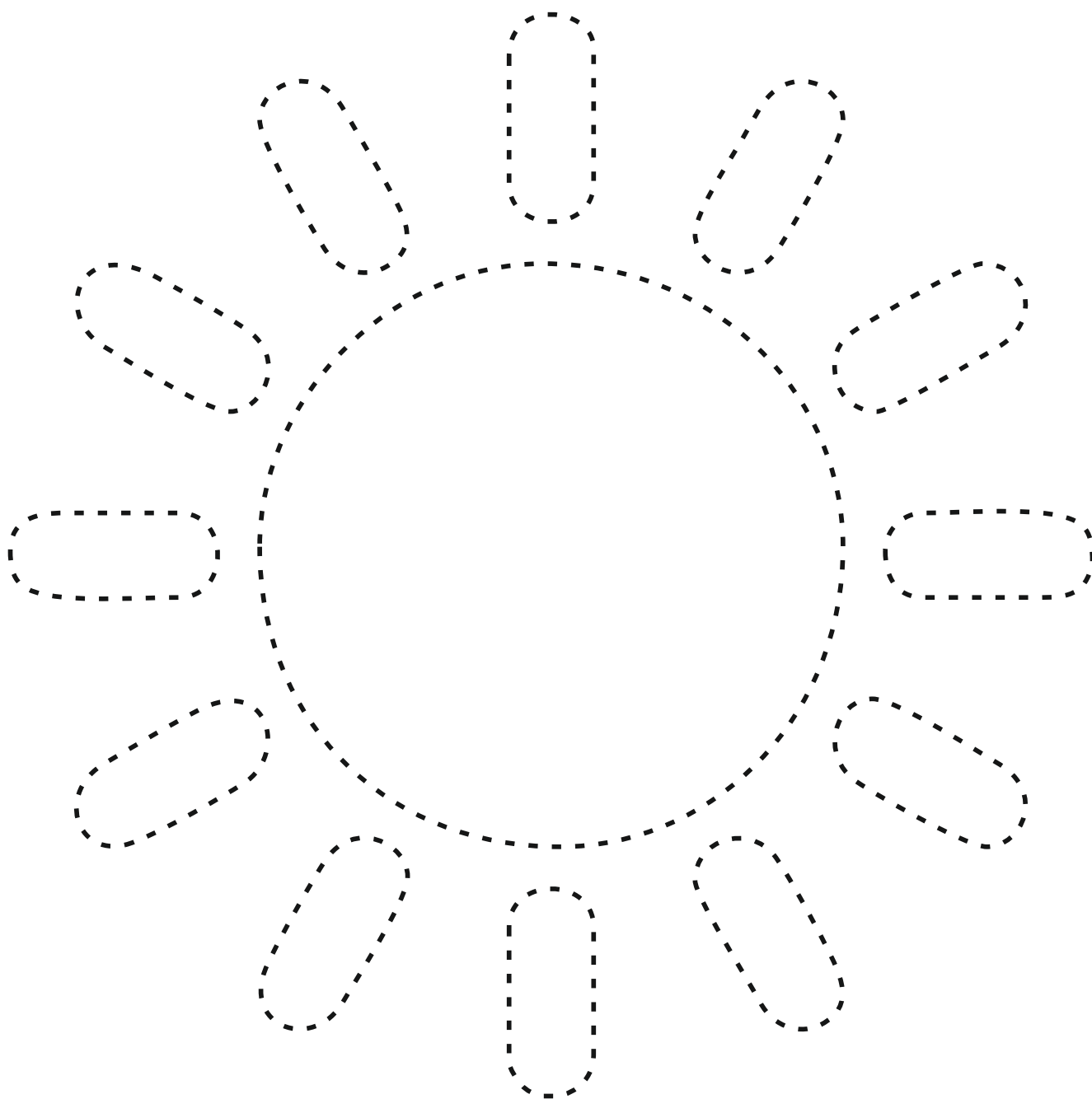

Stwórz krawat dla taty. Narysuj po śladzie i pokoloruj obrazek.

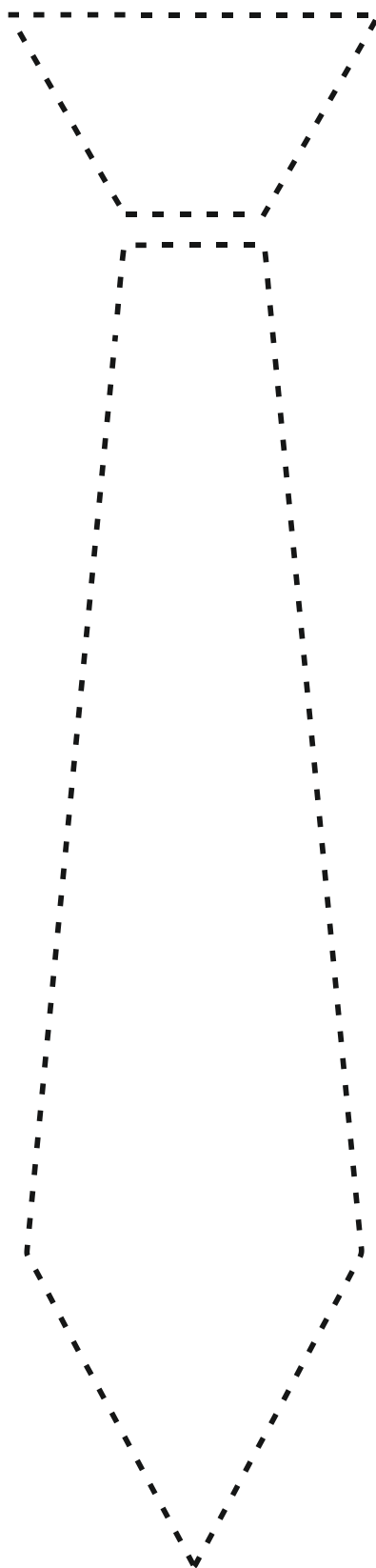

Narysuj po śladzie i pokoloruj obrazek.

